

CA101339

MODEL 1148F

148 x 90 x 68

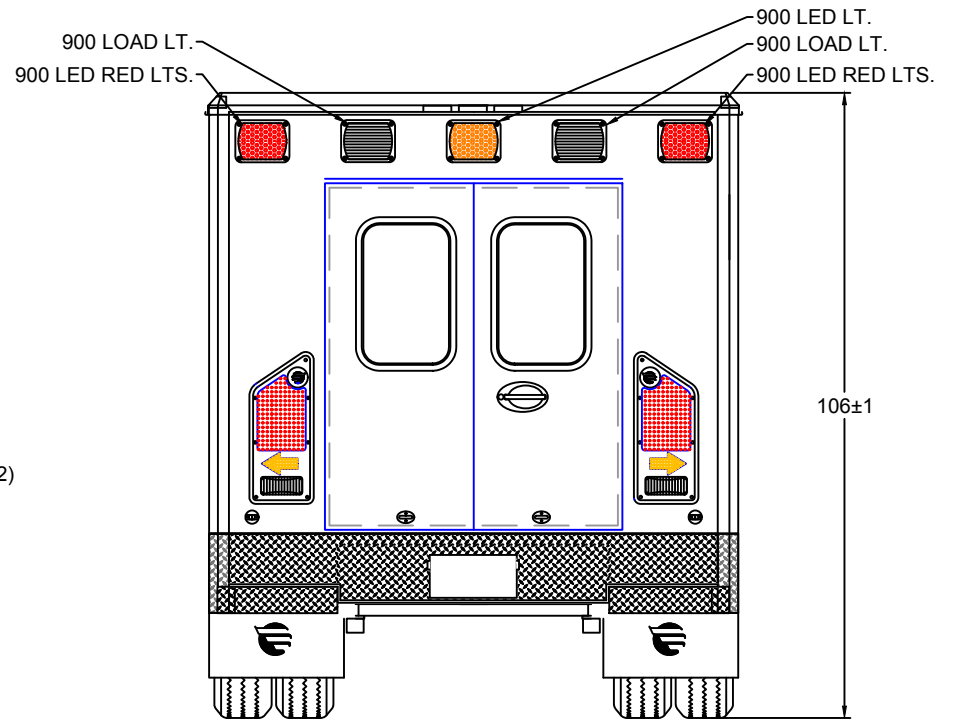
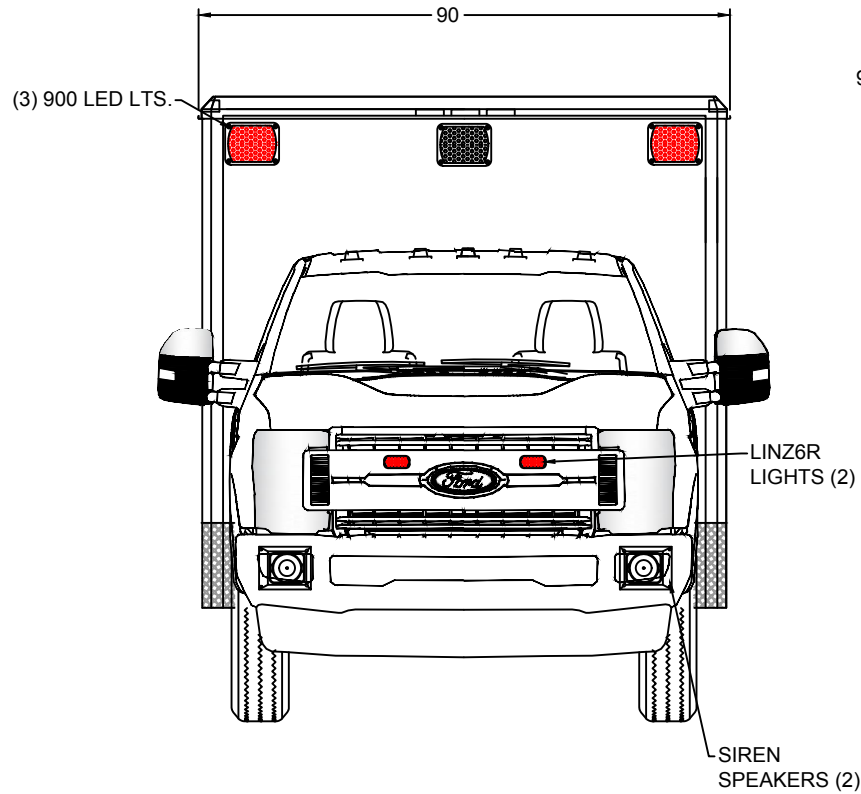

EXTERIOR COMPARTMENT DIMENSIONS IN INCHES

INTERIOR DIMENSIONS				PASS THRU		INTERIOR DIMENSIONS				JAMB OPENING	
COMPT.	HEIGHT	WIDTH	DEPTH	HEIGHT	WIDTH	COMPT.	HEIGHT	WIDTH	DEPTH	HEIGHT	WIDTH



TYPE 1 FORD 2021
FRONT / REAR
EXTERIOR VIEWS

BE ADVISED THAT THESE ARE PRELIMINARY LAYOUTS INTENDED TO ILLUSTRATE DESIGN INTENT AND DIMENSIONS ARE FOR REFERENCE ONLY PRIOR TO FINAL ENGINEERING

DATE: 2/10/21

SCALE

DWN BY AP

DWG NO 1 / 12

49" AISLE

CA101339

MODEL 1148F

148 x 90 x 68

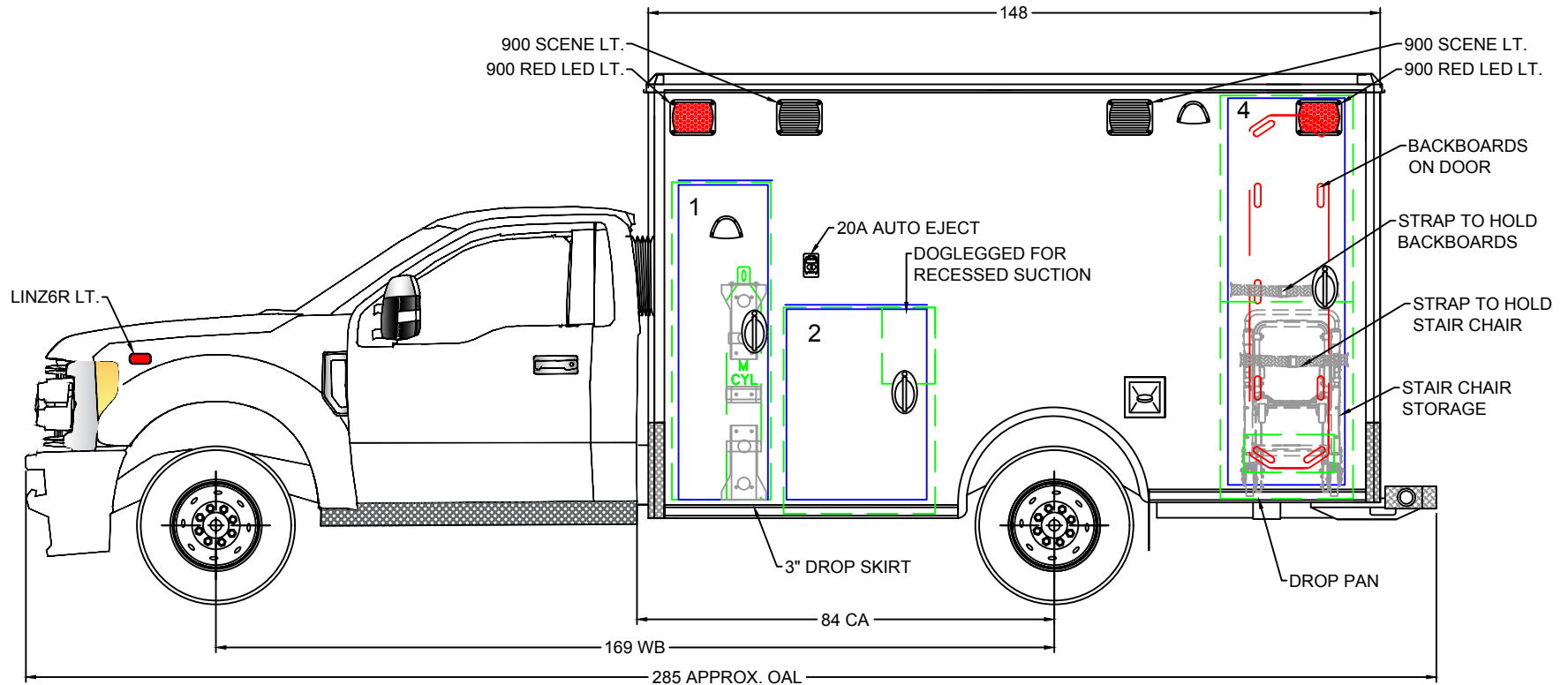

BE ADVISED THAT THESE ARE PRELIMINARY LAYOUTS INTENDED TO ILLUSTRATE DESIGN INTENT AND DIMENSIONS ARE FOR REFERENCE ONLY PRIOR TO FINAL ENGINEERING

EXTERIOR COMPARTMENT DIMENSIONS IN INCHES													
INTERIOR DIMENSIONS				JAMB OPENING		INTERIOR DIMENSIONS				JAMB OPENING			
COMPT.	HEIGHT	WIDTH	DEPTH	HEIGHT	WIDTH	COMPT.	HEIGHT	WIDTH	DEPTH	HEIGHT	WIDTH		
1	64.00	20.00	15.00	63.50	18.00								
2	41.75	30.50	15.00	38.75	28.25								
4	82.50	26.75	8.00	77.75	23.50								
49" AISLE												DATE 2/10/21 DRAWN BY AP	SCALE DWG NO 2 / 12

TYPE 1 FORD 2021

LEFT EXT. VIEW

CA101339

MODEL 1148F

148 x 90 x 68

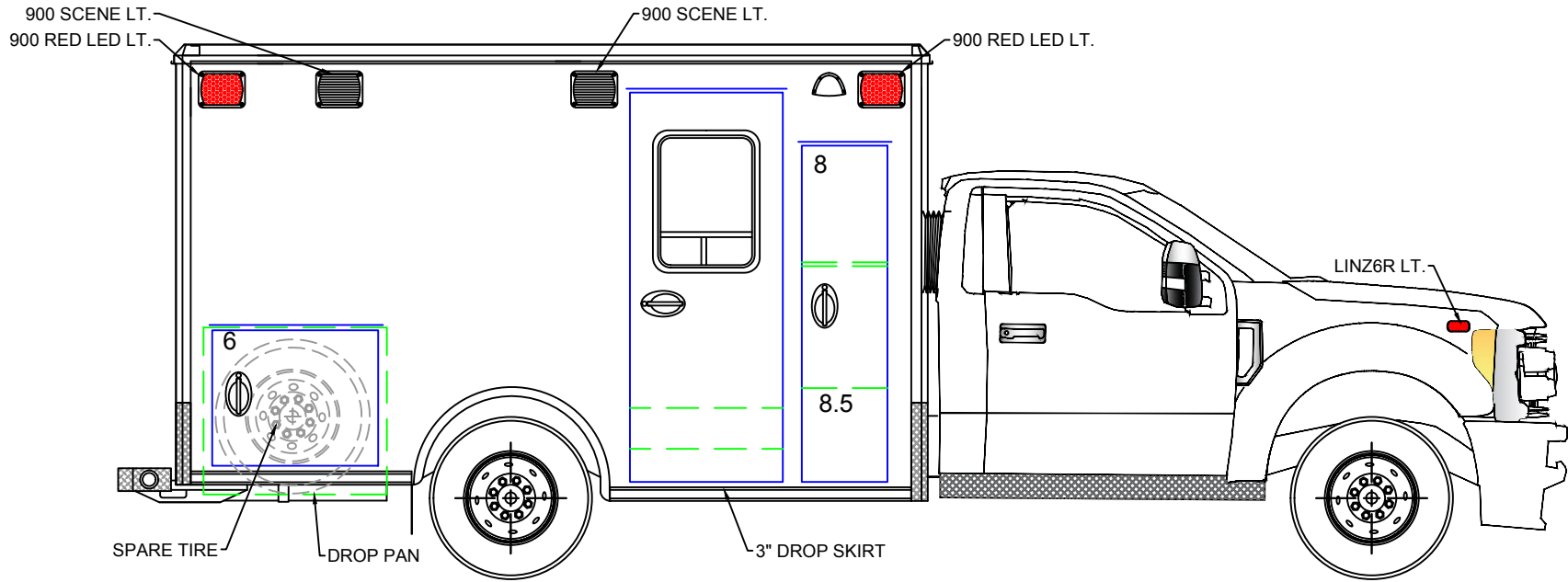

BE ADVISED THAT THESE ARE PRELIMINARY LAYOUTS INTENDED TO ILLUSTRATE DESIGN INTENT AND DIMENSIONS ARE FOR REFERENCE ONLY PRIOR TO FINAL ENGINEERING

EXTERIOR COMPARTMENT DIMENSIONS IN INCHES												
INTERIOR DIMENSIONS				JAMB OPENING		INTERIOR DIMENSIONS				JAMB OPENING		
COMPT.	HEIGHT	WIDTH	DEPTH	HEIGHT	WIDTH	COMPT.	HEIGHT	WIDTH	DEPTH	HEIGHT	WIDTH	
8				64.75	16.75							
8.5	18.50	19.00	18.75									
6	32.75	38.00	15.50	26.75	34.50							
49" AISLE												DATE: 2/10/21 SCALE: DRAWN BY: AP DWG NO: 3 / 12

TYPE 1 FORD 2021

RIGHT EXT. VIEW

CA101339

MODEL 1148F

148 x 90 x 68

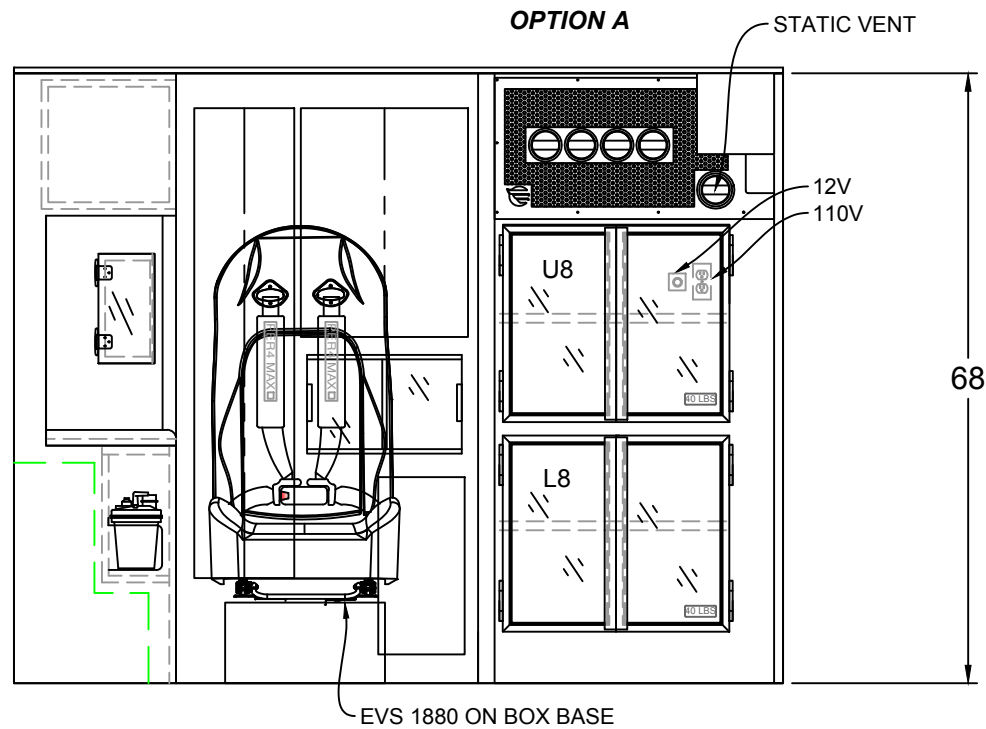

BE ADVISED THAT THESE ARE PRELIMINARY LAYOUTS INTENDED TO ILLUSTRATE DESIGN INTENT AND DIMENSIONS ARE FOR REFERENCE ONLY PRIOR TO FINAL ENGINEERING

<p>CABINET WEIGHT RATINGS: RESTOCKING = 30 LBS. NON-RESTOCKING = 40 LBS.</p>	INTERIOR CABINET DIMENSIONS IN INCHES								 TYPE 1 FORD 2021 BULKHEAD INTERIOR
	CABINET	HEIGHT	WIDTH	DEPTH	CABINET	HEIGHT	WIDTH	DEPTH	
	U8	22.50	31.50	19.75					
	L8	22.50	31.50	19.75					
								DATE 2/10/21	SCALE
								DRAWN BY AP	DWG NO 4 / 12

49" AISLE

CA101339

MODEL 1148F

148 x 90 x 68

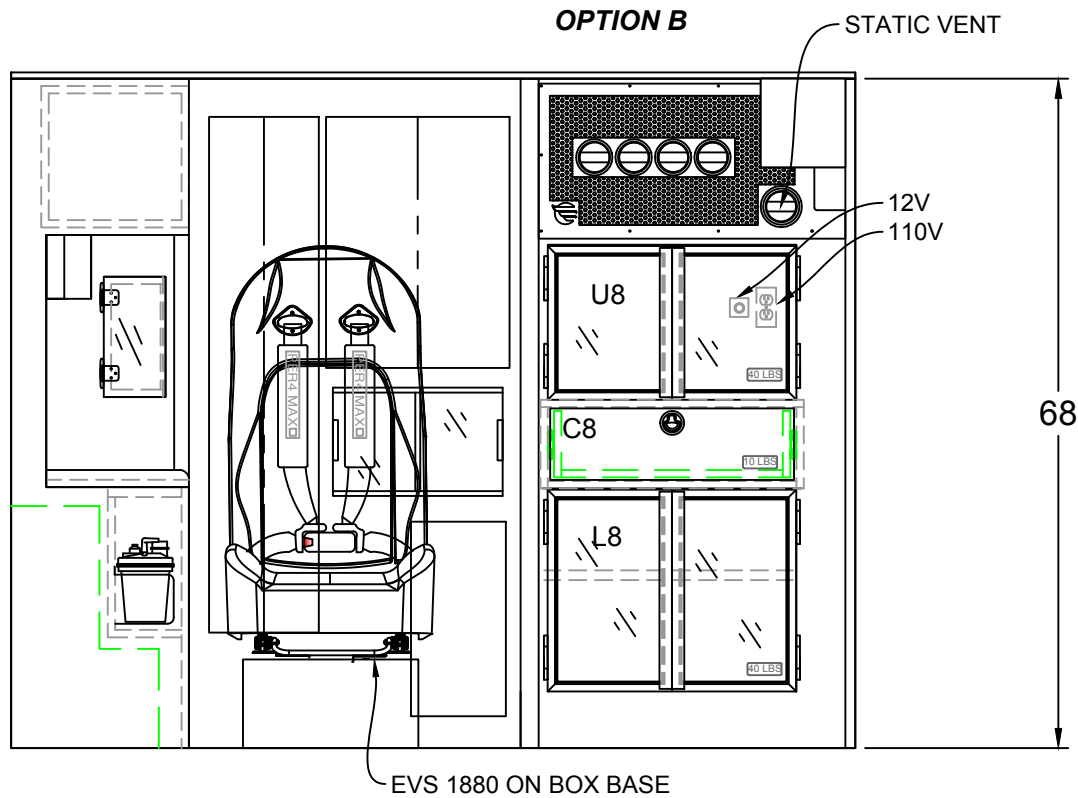

EVS 1880 ON BOX BASE

BE ADVISED THAT THESE ARE PRELIMINARY LAYOUTS INTENDED TO ILLUSTRATE DESIGN INTENT AND DIMENSIONS ARE FOR REFERENCE ONLY PRIOR TO FINAL ENGINEERING

<p>CABINET WEIGHT RATINGS: RESTOCKING = 30 LBS. NON-RESTOCKING = 40 LBS.</p>	<p>INTERIOR CABINET DIMENSIONS IN INCHES</p>								 TYPE 1 FORD 2021 BULKHEAD INTERIOR	
	CABINET	HEIGHT	WIDTH	DEPTH	CABINET	HEIGHT	WIDTH	DEPTH		
	U8	15.00	31.50	19.75						
	C8	6.00	22.50	18.25						
	L8	20.50	31.50	19.75						
									DATE 2/10/21	SCALE
									DRAWN BY AP	DWG NO 5 / 12

49" AISLE

CA101339

MODEL 1148F

148 x 90 x 68

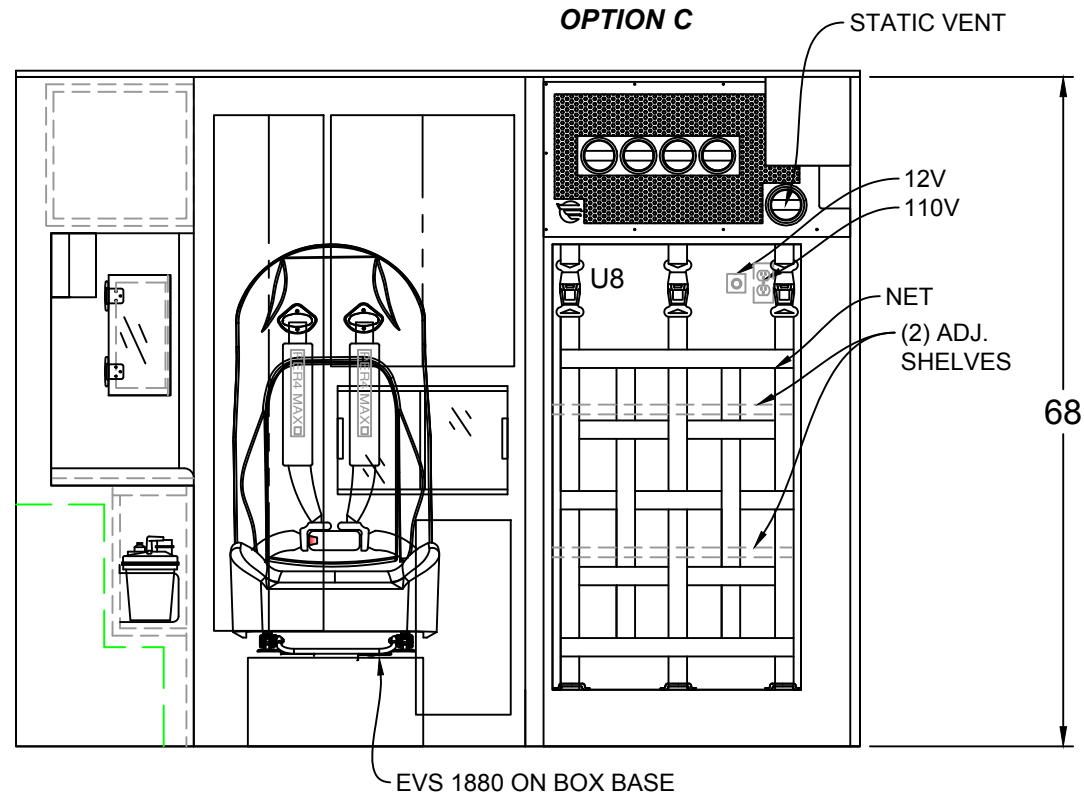

BE ADVISED THAT THESE ARE PRELIMINARY LAYOUTS INTENDED TO ILLUSTRATE DESIGN INTENT AND DIMENSIONS ARE FOR REFERENCE ONLY PRIOR TO FINAL ENGINEERING

<p><u>CABINET WEIGHT RATINGS:</u> RESTOCKING = 30 LBS. NON-RESTOCKING = 40 LBS.</p>	INTERIOR CABINET DIMENSIONS IN INCHES								 TYPE 1 FORD 2021 BULKHEAD INTERIOR
	CABINET	HEIGHT	WIDTH	DEPTH	CABINET	HEIGHT	WIDTH	DEPTH	
	U8	46.00	31.50	19.75					
								DATE 2/10/21	SCALE
								DRAWN BY AP	DWG NO 6 / 12

49" AISLE

CA101339

MODEL 1148F

148 x 90 x 68

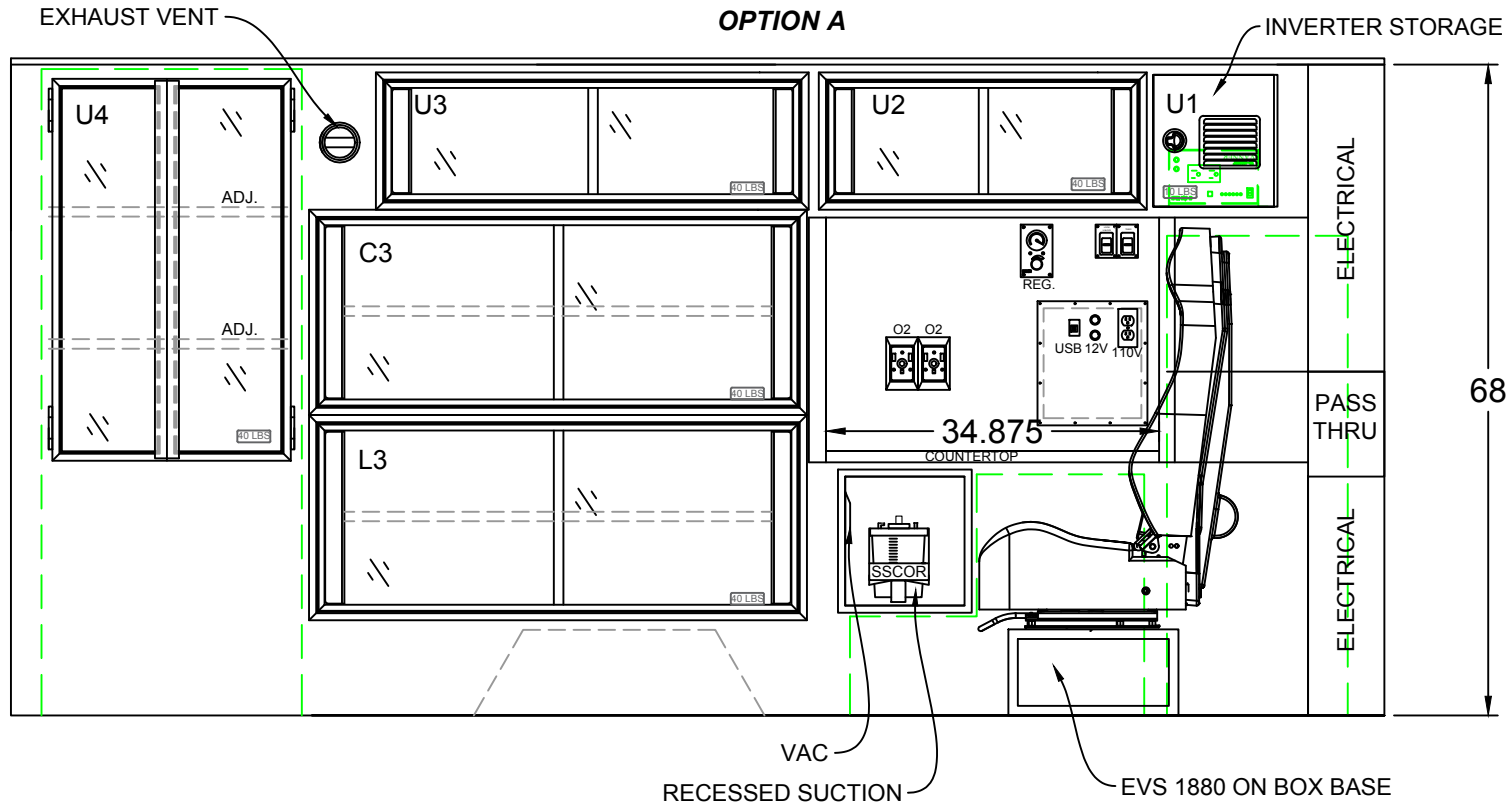

INTERIOR CABINET DIMENSIONS IN INCHES

CABINET	HEIGHT	WIDTH	DEPTH		CABINET	HEIGHT	WIDTH	DEPTH	
U4	40.00	24.75	7.00		L3	20.00	50.50	16.00	
U3	12.75	43.75	16.00						
U2	12.75	32.75	13.75						
U1	13.50	13.00	13.75						
C3	20.00	50.50	16.00						



TYPE 1 FORD 2021

LEFT INTERIOR

DATE:	2/10/21	SCALE:	
DWN BY:	AP	DWG NO:	7 / 12

49" AISLE

CABINET WEIGHT RATINGS:
 RESTOCKING = 30 LBS.
 NON-RESTOCKING = 40 LBS.

BE ADVISED THAT THESE ARE PRELIMINARY LAYOUTS INTENDED TO ILLUSTRATE DESIGN INTENT AND DIMENSIONS ARE FOR REFERENCE ONLY PRIOR TO FINAL ENGINEERING

CA101339

MODEL 1148F

148 x 90 x 68

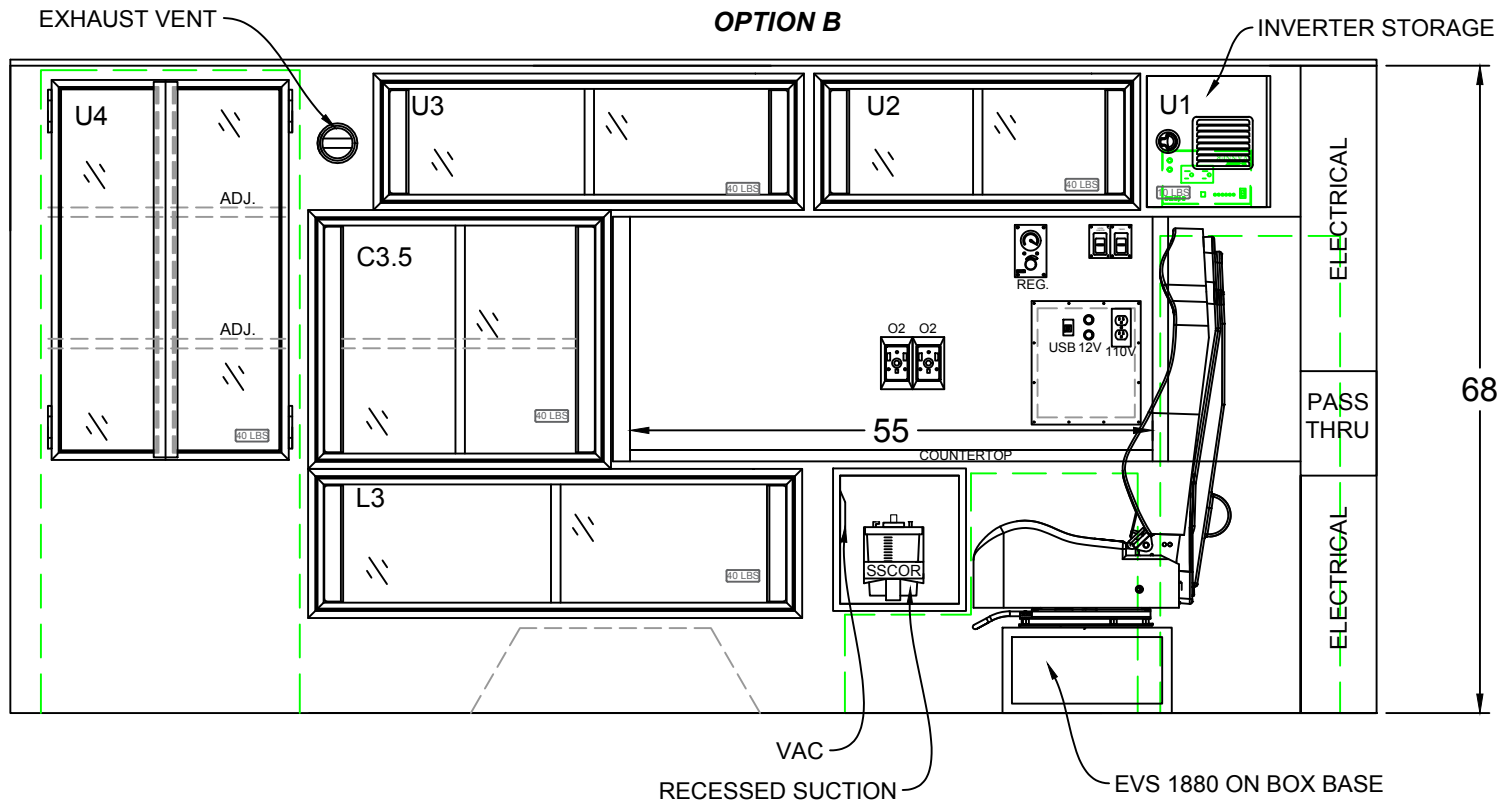

INTERIOR CABINET DIMENSIONS IN INCHES

CABINET	HEIGHT	WIDTH	DEPTH		CABINET	HEIGHT	WIDTH	DEPTH	
U4	40.00	24.75	7.00		L3	14.25	50.50	16.00	
U3	12.75	43.75	16.00						
U2	12.75	32.75	13.75						
U1	13.50	13.00	13.75						
C3.5	25.75	30.25	16.00						

49" AISLE

CABINET WEIGHT RATINGS:
 RESTOCKING = 30 LBS.
 NON-RESTOCKING = 40 LBS.

BE ADVISED THAT THESE ARE PRELIMINARY LAYOUTS INTENDED TO ILLUSTRATE DESIGN INTENT AND DIMENSIONS ARE FOR REFERENCE ONLY PRIOR TO FINAL ENGINEERING



TYPE 1 FORD 2021

LEFT INTERIOR

DATE:	2/10/21	SCALE:	
DWN BY:	AP	DWG NO:	8 / 12

CA101339

MODEL 1148F

148 x 90 x 68

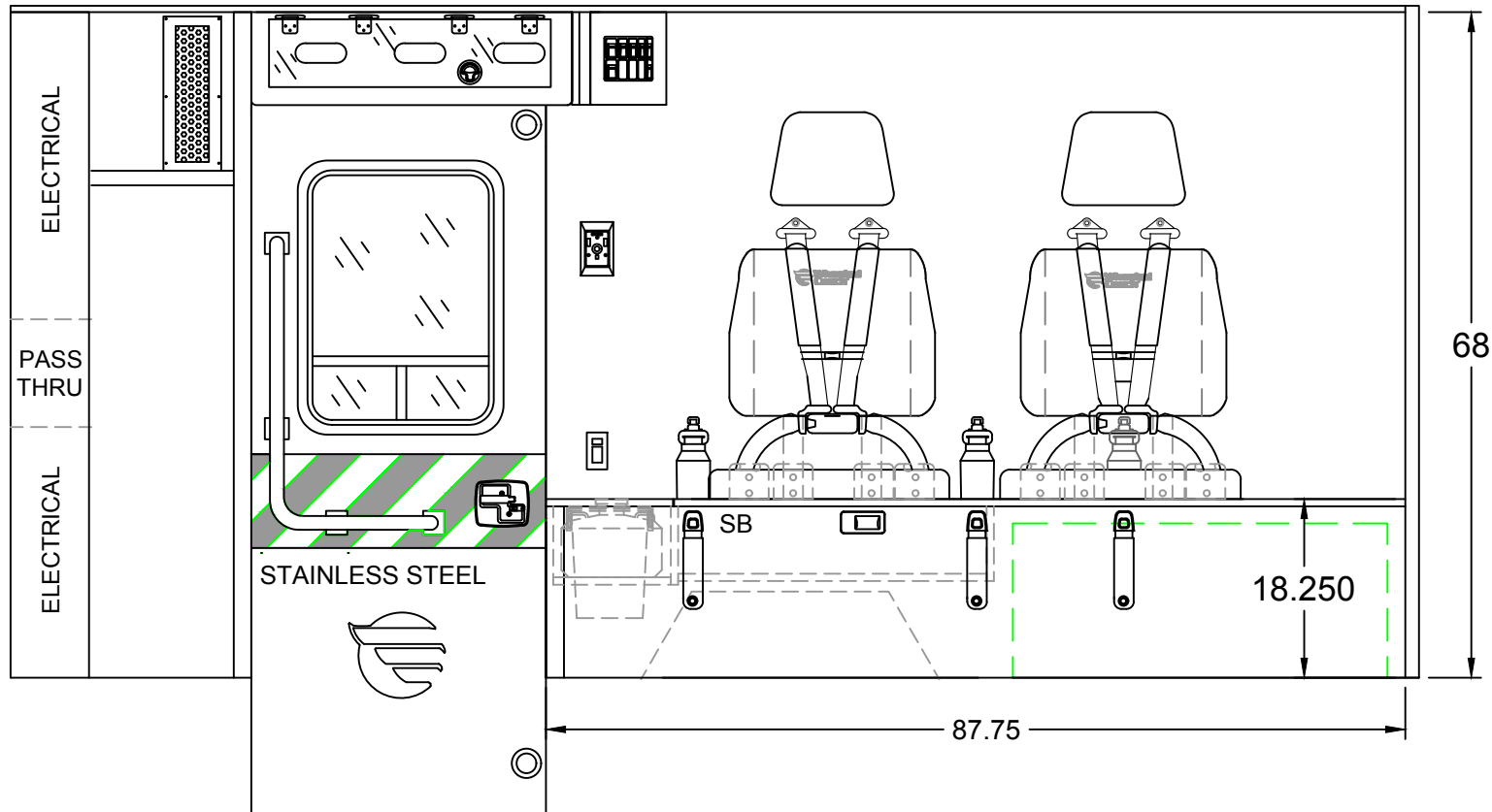

INTERIOR CABINET DIMENSIONS IN INCHES

COMPT.	HEIGHT	WIDTH	DEPTH	COMPT.	HEIGHT	WIDTH	DEPTH
SB	6.75	30.75	16.00				

49" AISLE

CABINET WEIGHT RATINGS:
 RESTOCKING = 30 LBS.
 NON-RESTOCKING = 40 LBS.

BE ADVISED THAT THESE ARE PRELIMINARY LAYOUTS INTENDED TO ILLUSTRATE DESIGN INTENT AND DIMENSIONS ARE FOR REFERENCE ONLY PRIOR TO FINAL ENGINEERING



TYPE 1 FORD 2021
 RIGHT INTERIOR

DATE: 2/10/21 SCALE:
 DWN BY: AP DWG NO: 9 / 12

CA101339

MODEL 1148F

148 x 90 x 68

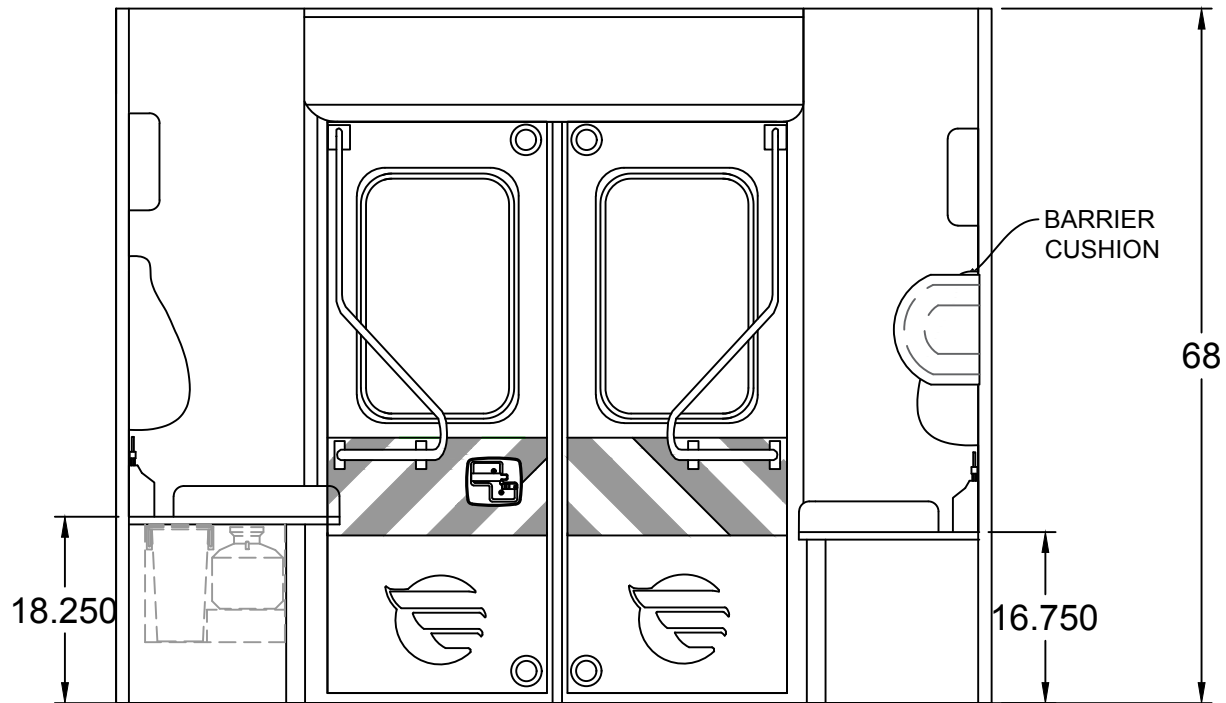

INTERIOR CABINET DIMENSIONS IN INCHES



COMPT.	HEIGHT	WIDTH	DEPTH	COMPT.	HEIGHT	WIDTH	DEPTH

TYPE 1 FORD 2021
REAR BULKHEAD INTERIOR

DATE: 2/10/21 SCALE

DWG NO. 10 12

49" AISLE

CABINET WEIGHT RATINGS:
RESTOCKING = 30 LBS.
NON-RESTOCKING = 40 LBS.

BE ADVISED THAT THESE ARE PRELIMINARY LAYOUTS INTENDED TO ILLUSTRATE DESIGN INTENT AND DIMENSIONS ARE FOR REFERENCE ONLY PRIOR TO FINAL ENGINEERING

AP

CA101339

MODEL 1148F

148 x 90 x 68

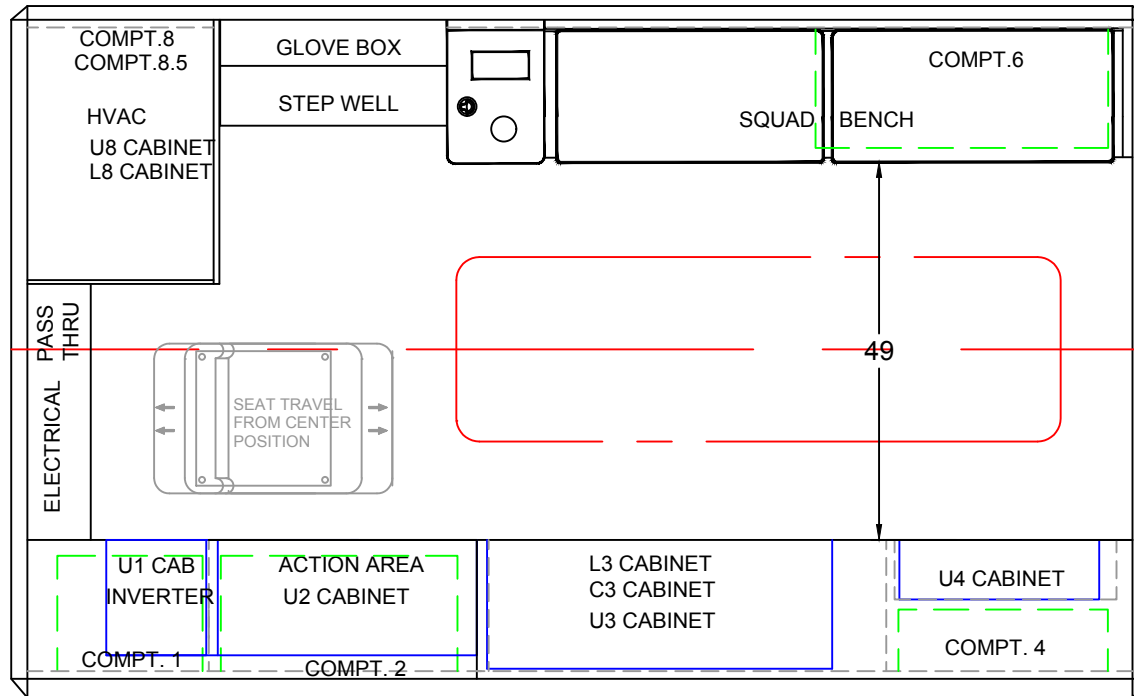

BE ADVISED THAT THESE ARE PRELIMINARY LAYOUTS INTENDED TO ILLUSTRATE DESIGN INTENT AND DIMENSIONS ARE FOR REFERENCE ONLY PRIOR TO FINAL ENGINEERING

INTERIOR CABINET DIMENSIONS IN INCHES

CABINET	HEIGHT	WIDTH	DEPTH	CABINET	HEIGHT	WIDTH	DEPTH



TYPE 1 FORD 2021
FLOOR PLAN

DATE:	2/10/21	SCALE:	
DWN BY:	AP	DWG NO:	11/12

49" AISLE

CA101339

MODEL 1148F

148 x 90 x 68

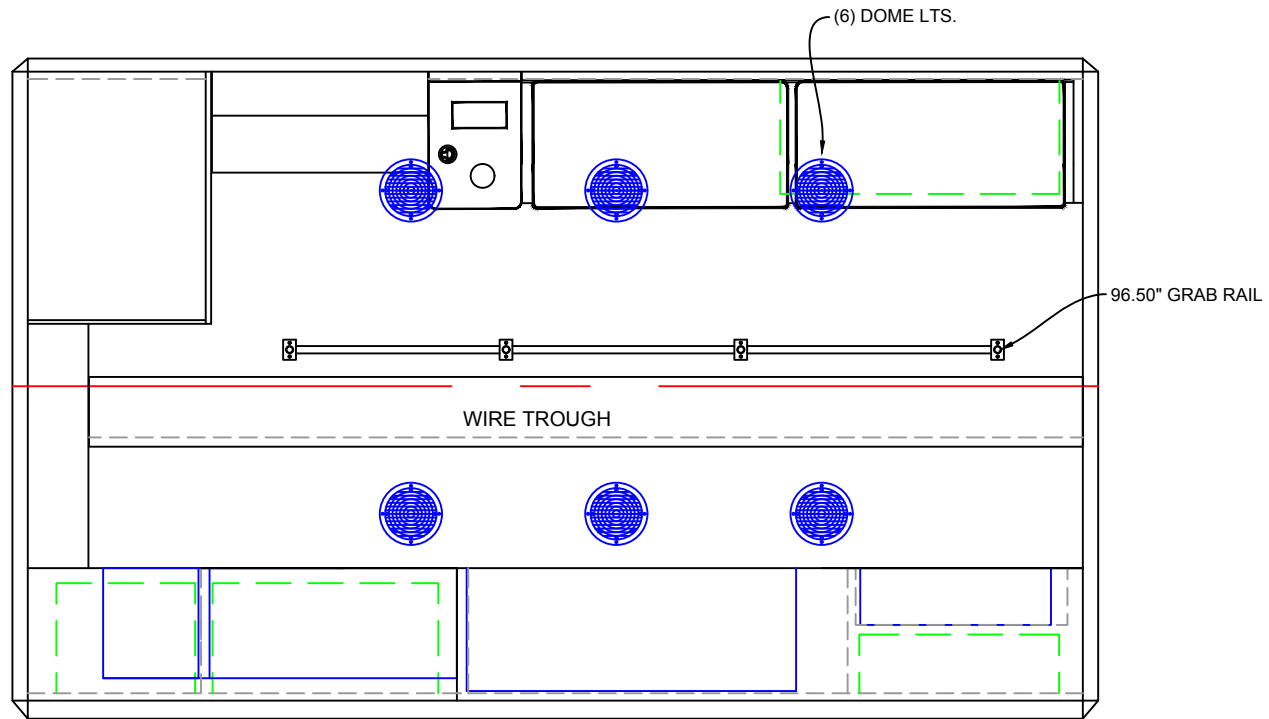

BE ADVISED THAT THESE ARE PRELIMINARY LAYOUTS INTENDED TO ILLUSTRATE DESIGN INTENT AND DIMENSIONS ARE FOR REFERENCE ONLY PRIOR TO FINAL ENGINEERING

INTERIOR CABINET DIMENSIONS IN INCHES								
CABINET	HEIGHT	WIDTH	DEPTH	CABINET	HEIGHT	WIDTH	DEPTH	
								TYPE 1 FORD 2021
								DATE: 2/10/21
								SCALE
								DWG NO
								12 12

49" AISLE