

CA101252

MODEL 1146D

146 x 90 x 68

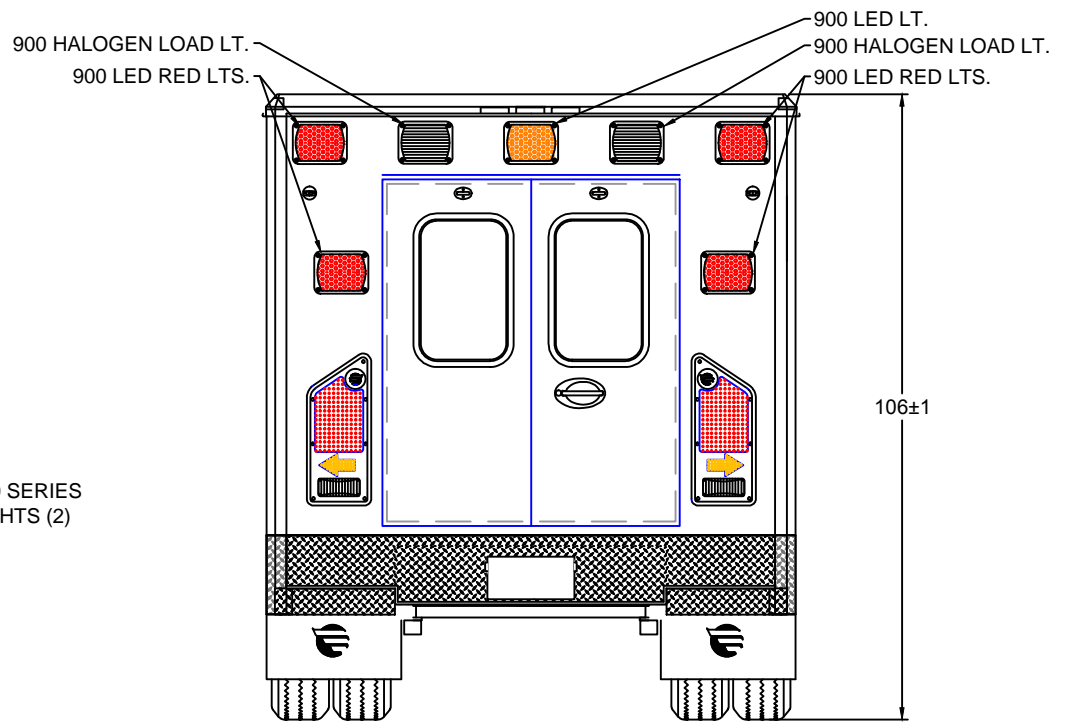
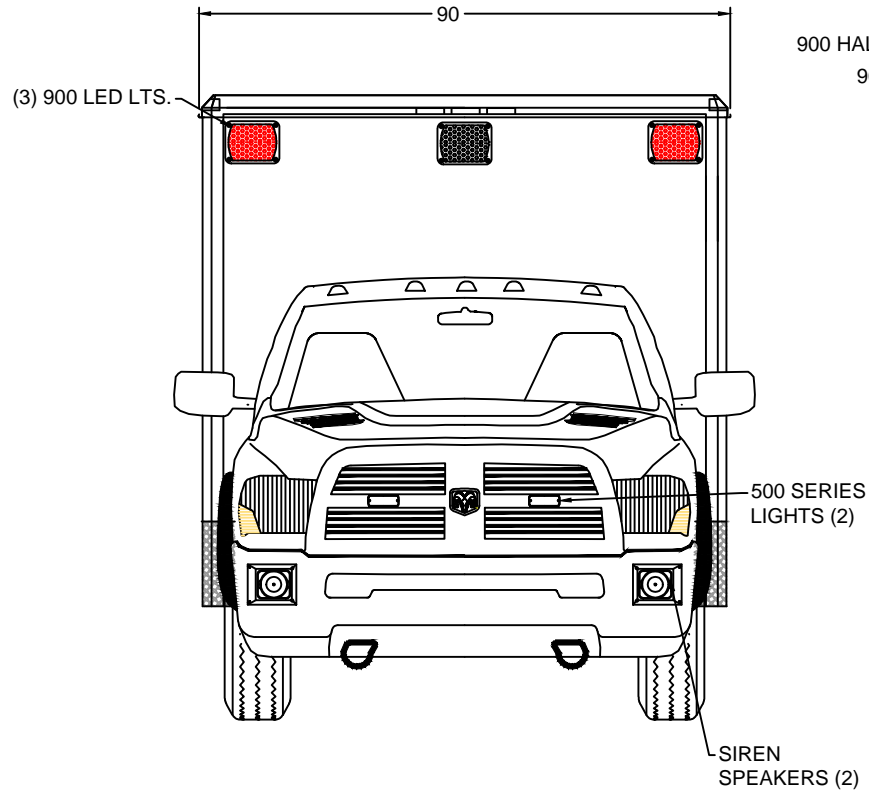

EXTERIOR COMPARTMENT DIMENSIONS IN INCHES

INTERIOR DIMENSIONS				PASS THRU		INTERIOR DIMENSIONS				JAMB OPENING	
COMPT.	HEIGHT	WIDTH	DEPTH	HEIGHT	WIDTH	COMPT.	HEIGHT	WIDTH	DEPTH	HEIGHT	WIDTH



TYPE 1 DODGE 2018  
FRONT / REAR  
EXTERIOR VIEWS

BE ADVISED THAT THESE ARE PRELIMINARY LAYOUTS INTENDED TO ILLUSTRATE DESIGN INTENT AND DIMENSIONS ARE FOR REFERENCE ONLY PRIOR TO FINAL ENGINEERING

DATE:	04/17/18	SCALE
DWN BY:	SG	DWG NO 1 / 9

49" AISLE

CA101252

MODEL 1146D

146 x 90 x 68

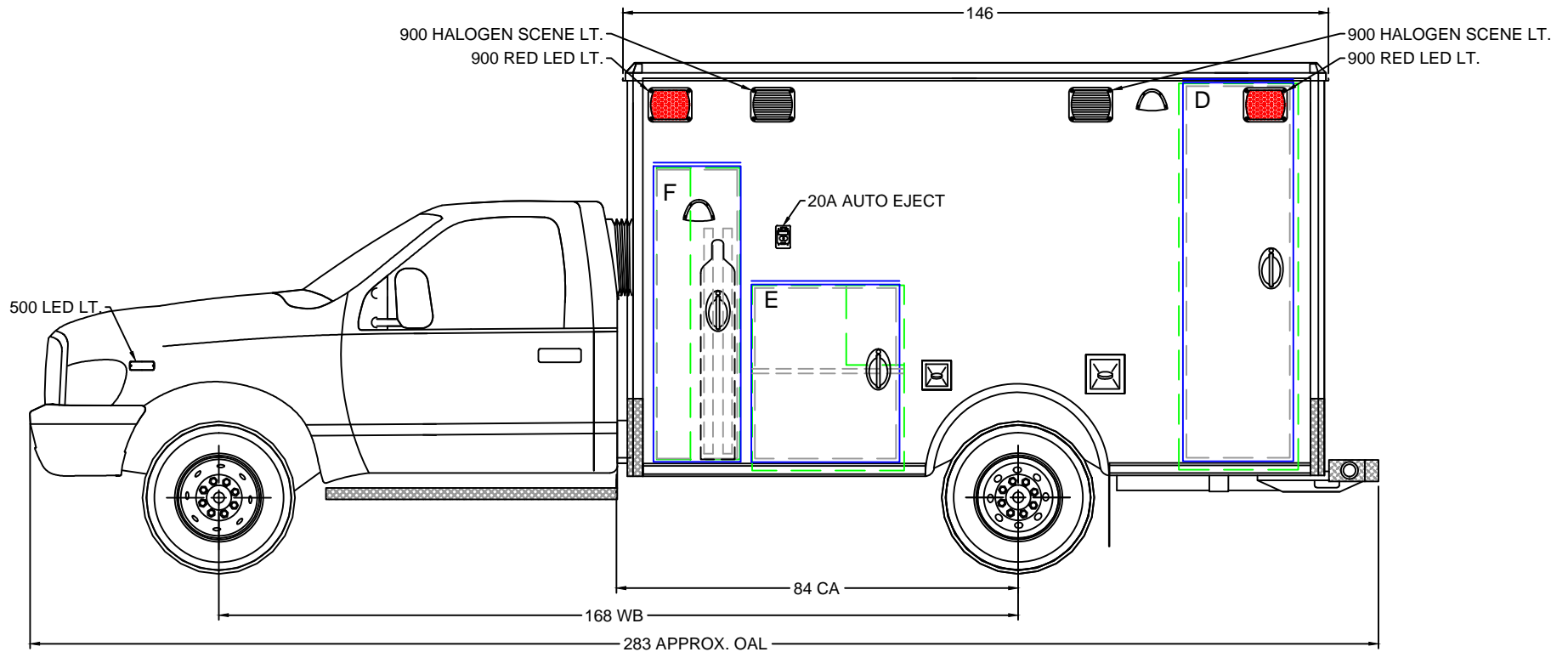

BE ADVISED THAT THESE ARE PRELIMINARY LAYOUTS INTENDED TO ILLUSTRATE DESIGN INTENT AND DIMENSIONS ARE FOR REFERENCE ONLY PRIOR TO FINAL ENGINEERING

EXTERIOR COMPARTMENT DIMENSIONS IN INCHES												
INTERIOR DIMENSIONS				JAMB OPENING		INTERIOR DIMENSIONS				JAMB OPENING		
COMPT.	HEIGHT	WIDTH	DEPTH	HEIGHT	WIDTH	COMPT.	HEIGHT	WIDTH	DEPTH	HEIGHT	WIDTH	
D	81.00	25.00	8.00	77.75	21.50							
E	38.75	31.75	15.00	35.75	29.50							
F	61.00	17.50	15.00	60.50	16.75							
49" AISLE												<small>DATE</small> 04/17/18 <small>SCALE</small> <small>DRAWN BY</small> SG <small>DWG NO</small> 2 / 9

CA101252

MODEL 1146D

146 x 90 x 68

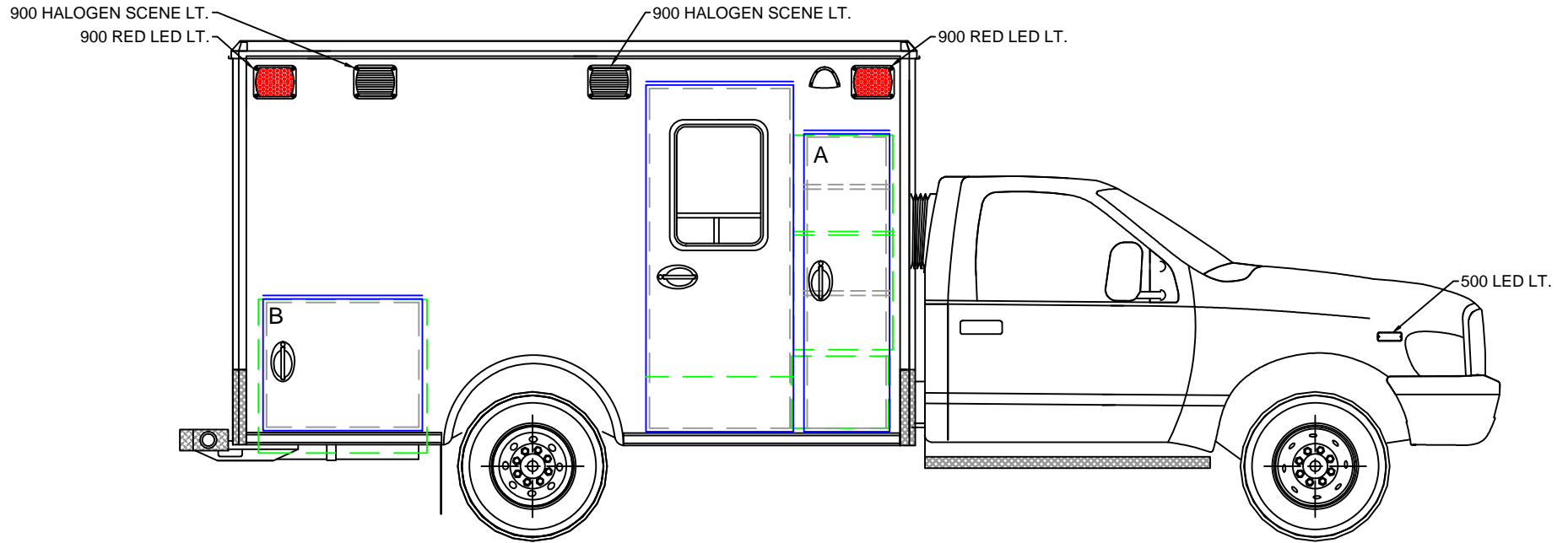

BE ADVISED THAT THESE ARE PRELIMINARY LAYOUTS INTENDED TO ILLUSTRATE DESIGN INTENT AND DIMENSIONS ARE FOR REFERENCE ONLY PRIOR TO FINAL ENGINEERING

EXTERIOR COMPARTMENT DIMENSIONS IN INCHES													
INTERIOR DIMENSIONS				JAMB OPENING		INTERIOR DIMENSIONS				JAMB OPENING			
COMPT.	HEIGHT	WIDTH	DEPTH	HEIGHT	WIDTH	COMPT.	HEIGHT	WIDTH	DEPTH	HEIGHT	WIDTH		
A	45.25	21.25	32.50	61.50	16.75								
LOWER-A	15.50	19.00	18.75										
B	33.00	36.00	15.50	26.75	32.50								
49" AISLE												DATE 04/17/18 SCALE DRAWN BY SG DWG NO 3 / 9	

CA101252

MODEL 1146D

146 x 90 x 68

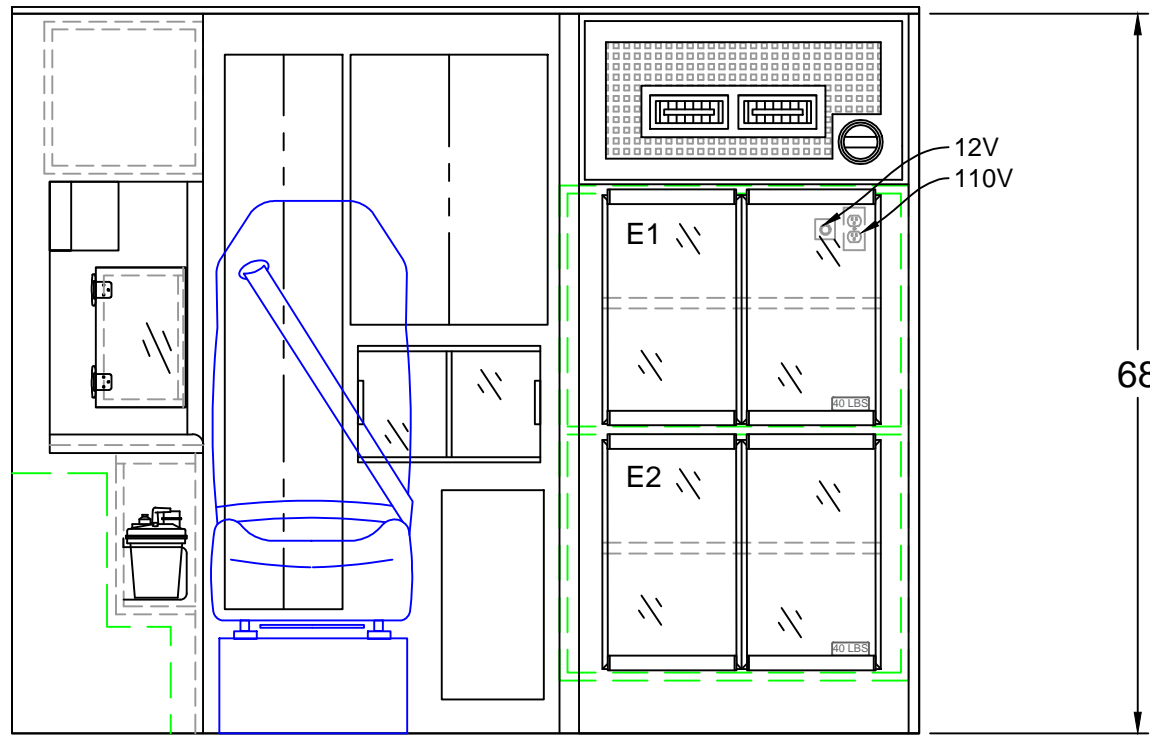

BE ADVISED THAT THESE ARE PRELIMINARY LAYOUTS INTENDED TO ILLUSTRATE DESIGN INTENT AND DIMENSIONS ARE FOR REFERENCE ONLY PRIOR TO FINAL ENGINEERING

<p>CABINET WEIGHT RATINGS:                  RESTOCKING = 30 LBS.                  NON-RESTOCKING = 40 LBS.</p>	INTERIOR CABINET DIMENSIONS IN INCHES								 <p>TYPE 1 DODGE 2018                  BULKHEAD INTERIOR</p>
	CABINET	HEIGHT	WIDTH	DEPTH	CABINET	HEIGHT	WIDTH	DEPTH	
	E1	22.00	32.50	21.25					
	E2	22.00	32.50	21.25					
								DATE 04/17/18	SCALE
								DRAWN BY SG	DWG NO 4 / 9

49" AISLE

CA101252

MODEL 1146D

146 x 90 x 68

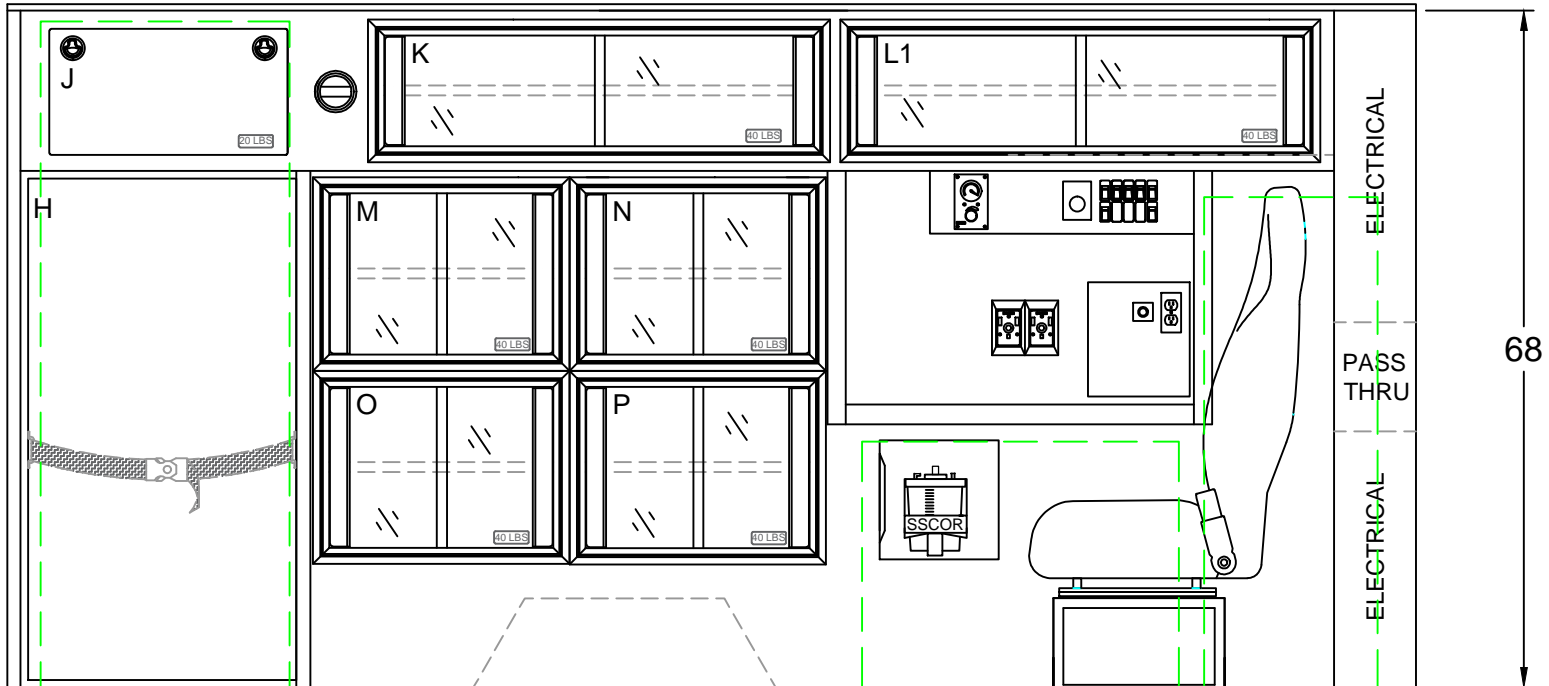

INTERIOR CABINET DIMENSIONS IN INCHES

CABINET	HEIGHT	WIDTH	DEPTH		CABINET	HEIGHT	WIDTH	DEPTH	
H	50.50	26.75	7.75		M-N	18.00	24.25	16.00	
J	12.75	24.00	7.00		O-P	18.00	24.25	16.00	
K	12.75	45.00	16.00						
L1	12.75	46.75	13.50						



TYPE 1 DODGE 2018

LEFT INTERIOR

DATE:	04/17/18	SCALE:	
DWN BY:	SG	DWG NO:	5 / 9

49" AISLE

CABINET WEIGHT RATINGS:  
 RESTOCKING = 30 LBS.  
 NON-RESTOCKING = 40 LBS.

BE ADVISED THAT THESE ARE PRELIMINARY LAYOUTS INTENDED TO ILLUSTRATE DESIGN INTENT AND DIMENSIONS ARE FOR REFERENCE ONLY PRIOR TO FINAL ENGINEERING

CA101252

MODEL 1146D

146 x 90 x 68

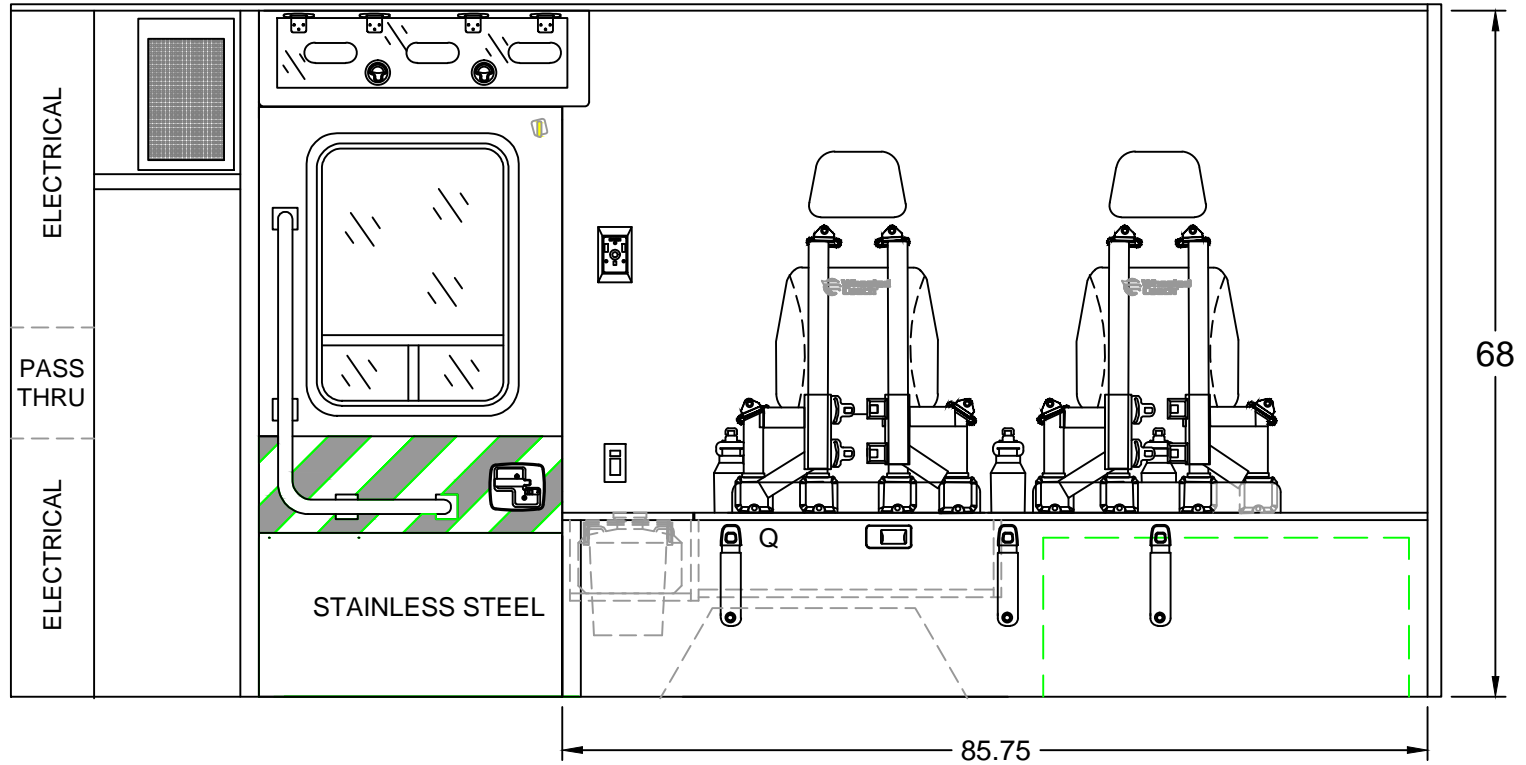

INTERIOR CABINET DIMENSIONS IN INCHES

COMPT.	HEIGHT	WIDTH	DEPTH		COMPT.	HEIGHT	WIDTH	DEPTH	
Q	6.75	29.25	16.00						

49" AISLE

**CABINET WEIGHT RATINGS:**  
 RESTOCKING = 30 LBS.  
 NON-RESTOCKING = 40 LBS.

BE ADVISED THAT THESE ARE PRELIMINARY LAYOUTS INTENDED TO ILLUSTRATE DESIGN INTENT AND DIMENSIONS ARE FOR REFERENCE ONLY PRIOR TO FINAL ENGINEERING



TYPE 1 DODGE 2018  
 RIGHT INTERIOR

DATE: 04/17/18

SCALE

DWN BY

SG

DWG NO

6 / 9

CA101252

MODEL 1146D

146 x 90 x 68

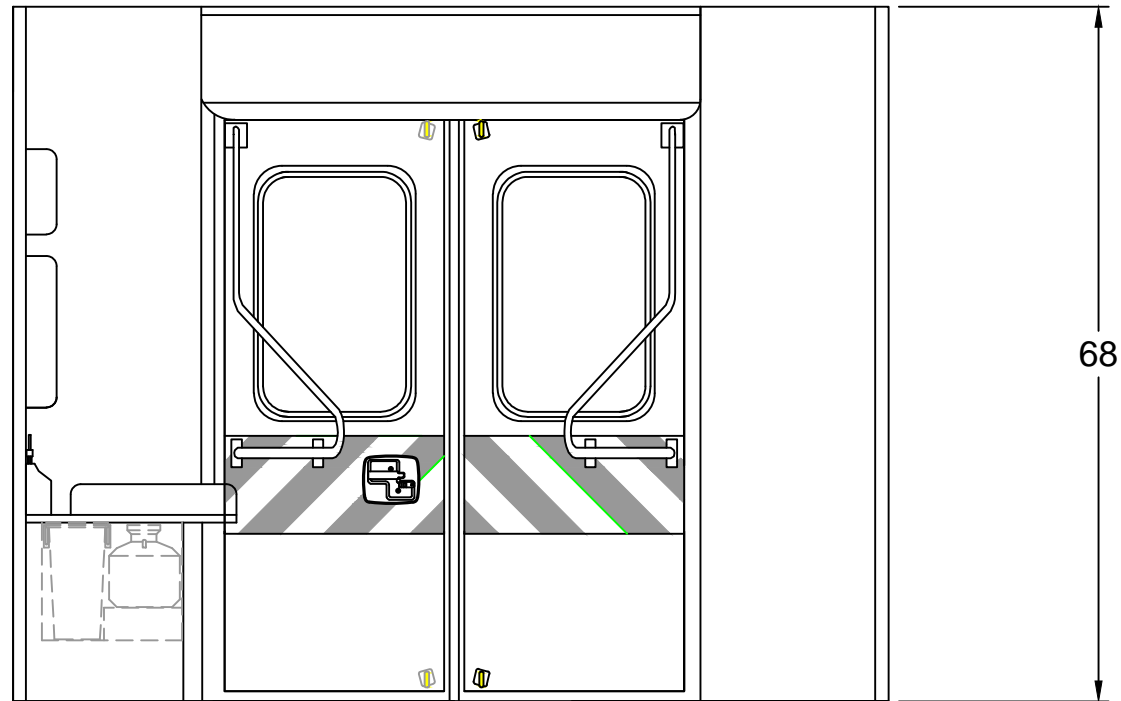

INTERIOR CABINET DIMENSIONS IN INCHES



TYPE 1 DODGE 2018

REAR BULKHEAD INTERIOR

DATE:	04/17/18	SCALE:	
DRAWN BY:	SG	DWG NO:	7 / 9

COMPT.	HEIGHT	WIDTH	DEPTH		COMPT.	HEIGHT	WIDTH	DEPTH	

49" AISLE

**CABINET WEIGHT RATINGS:**  
 RESTOCKING = 30 LBS.  
 NON-RESTOCKING = 40 LBS.

BE ADVISED THAT THESE ARE PRELIMINARY LAYOUTS INTENDED TO ILLUSTRATE DESIGN INTENT AND DIMENSIONS ARE FOR REFERENCE ONLY PRIOR TO FINAL ENGINEERING

CA101252

MODEL 1146D

146 x 90 x 68

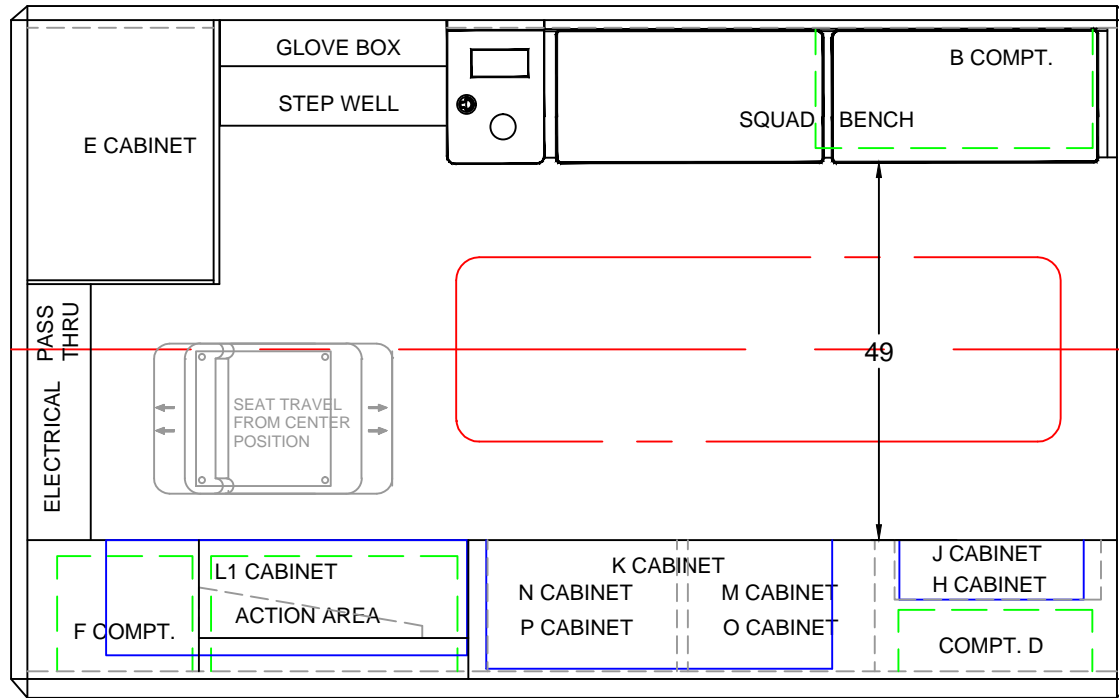

BE ADVISED THAT THESE ARE PRELIMINARY LAYOUTS INTENDED TO ILLUSTRATE DESIGN INTENT AND DIMENSIONS ARE FOR REFERENCE ONLY PRIOR TO FINAL ENGINEERING

INTERIOR CABINET DIMENSIONS IN INCHES									
CABINET	HEIGHT	WIDTH	DEPTH	CABINET	HEIGHT	WIDTH	DEPTH		
									TYPE 1 DODGE 2018 FLOOR PLAN
									DATE: 04/17/18      SCALE:
									DWN BY: SG      DWG NO: 8 / 9

49" AISLE



CA101252

MODEL 1146D

146 x 90 x 68

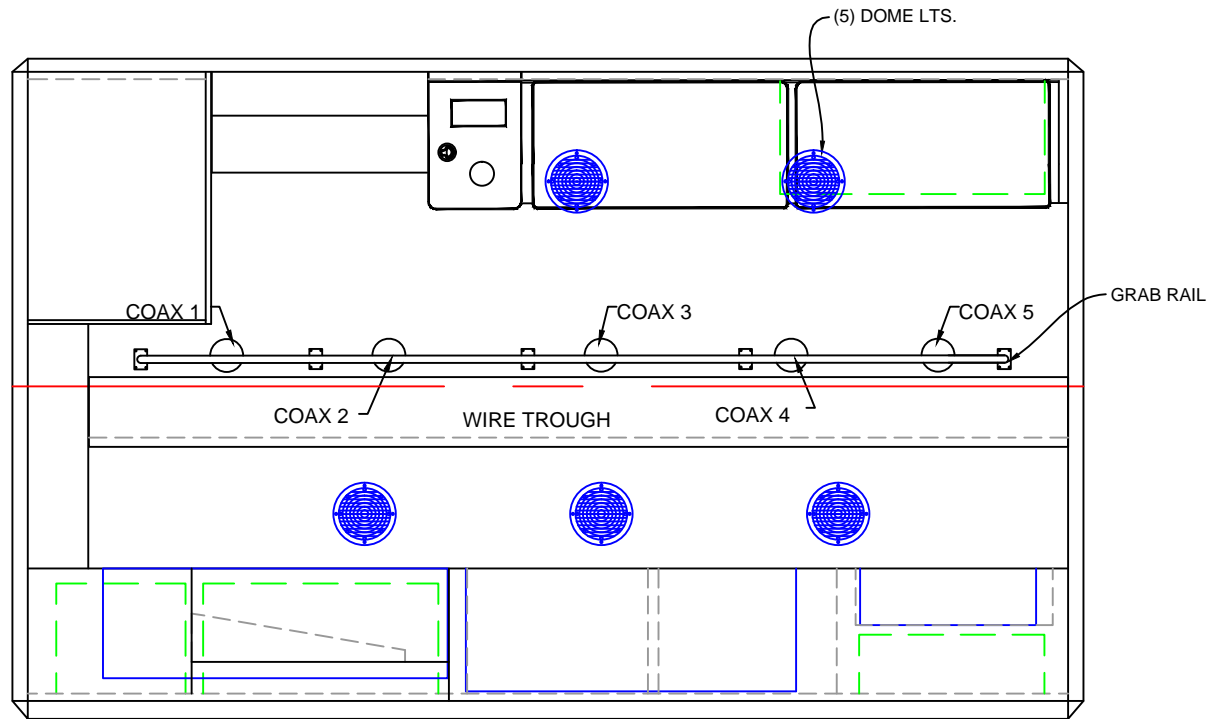

BE ADVISED THAT THESE ARE PRELIMINARY LAYOUTS INTENDED TO ILLUSTRATE DESIGN INTENT AND DIMENSIONS ARE FOR REFERENCE ONLY PRIOR TO FINAL ENGINEERING

INTERIOR CABINET DIMENSIONS IN INCHES

CABINET	HEIGHT	WIDTH	DEPTH	CABINET	HEIGHT	WIDTH	DEPTH



TYPE 1 DODGE 2018

LINER

DATE: 04/17/18 SCALE:   
 DWN BY: SG DWG NO: 9 / 9

49" AISLE