

CA163223

SPRINTER

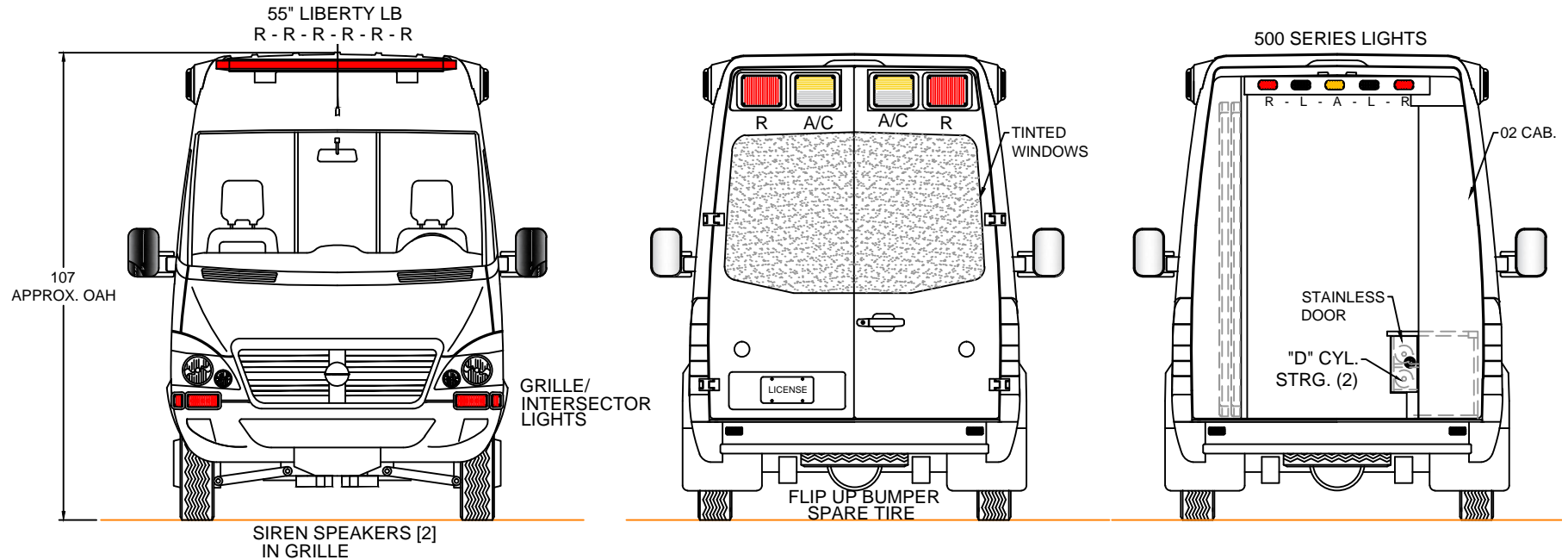

EXTERIOR COMPARTMENT DIMENSIONS IN INCHES

INTERIOR DIMENSIONS				PASS THRU		INTERIOR DIMENSIONS				JAMB OPENING	
COMPT.	HEIGHT	WIDTH	DEPTH	HEIGHT	WIDTH	COMPT.	HEIGHT	WIDTH	DEPTH	HEIGHT	WIDTH



TYPE II SPRINTER 2018
FRONT / REAR
EXTERIOR VIEWS

BE ADVISED THAT THESE ARE PRELIMINARY LAYOUTS INTENDED TO ILLUSTRATE DESIGN INTENT AND DIMENSIONS ARE FOR REFERENCE ONLY PRIOR TO FINAL ENGINEERING

DATE:	04/20/18	SCALE
DWN BY:	SG	DWG NO 1 / 9

CA163223

SPRINTER

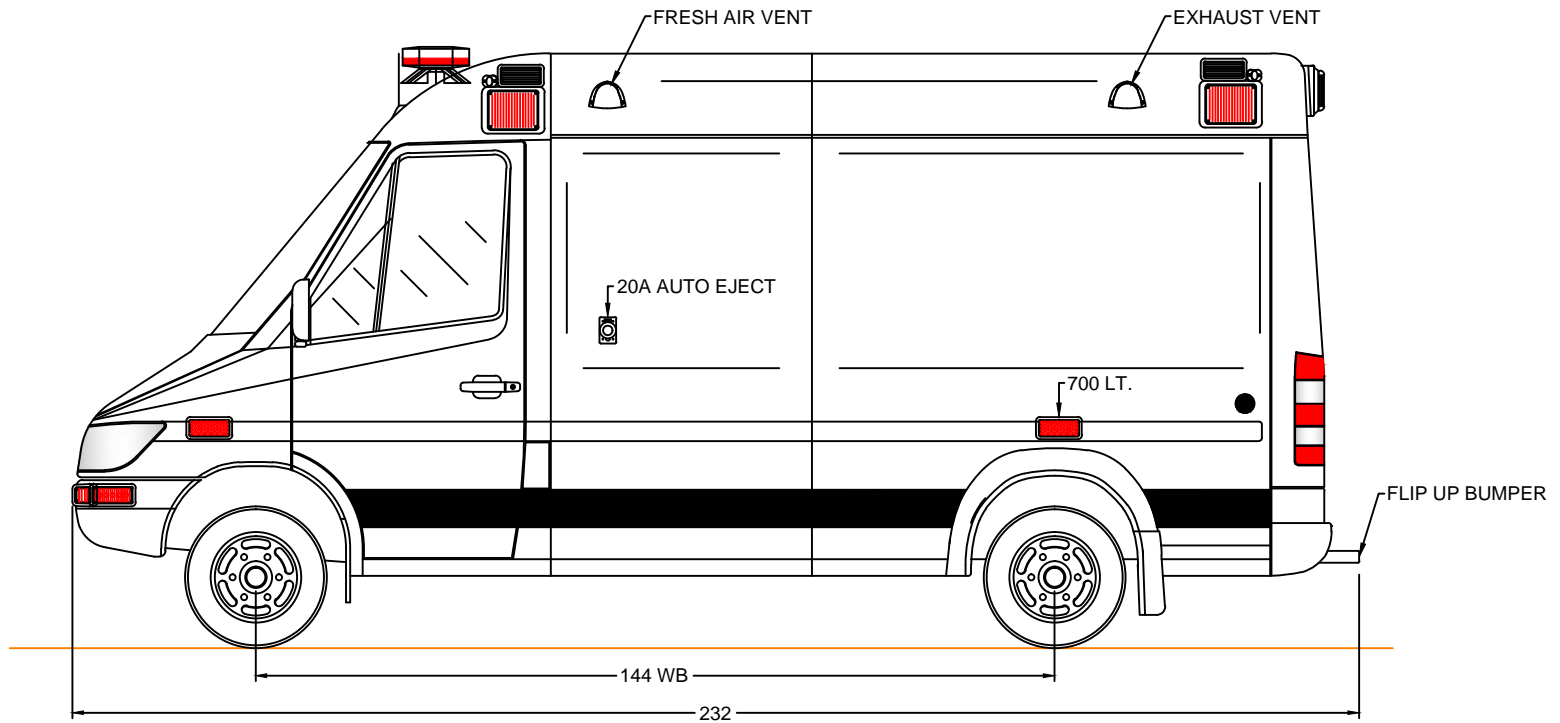

BE ADVISED THAT THESE ARE PRELIMINARY LAYOUTS INTENDED TO ILLUSTRATE DESIGN INTENT AND DIMENSIONS ARE FOR REFERENCE ONLY PRIOR TO FINAL ENGINEERING

EXTERIOR COMPARTMENT DIMENSIONS IN INCHES													
INTERIOR DIMENSIONS				JAMB OPENING		INTERIOR DIMENSIONS				JAMB OPENING			
COMPT.	HEIGHT	WIDTH	DEPTH	HEIGHT	WIDTH	COMPT.	HEIGHT	WIDTH	DEPTH	HEIGHT	WIDTH		
													TYPE II SPRINTER 2018 LEFT EXT. VIEW
										DATE	04/20/18	SCALE	
										DRAWN BY	SG	DWG NO	2 / 9

CA163223

SPRINTER

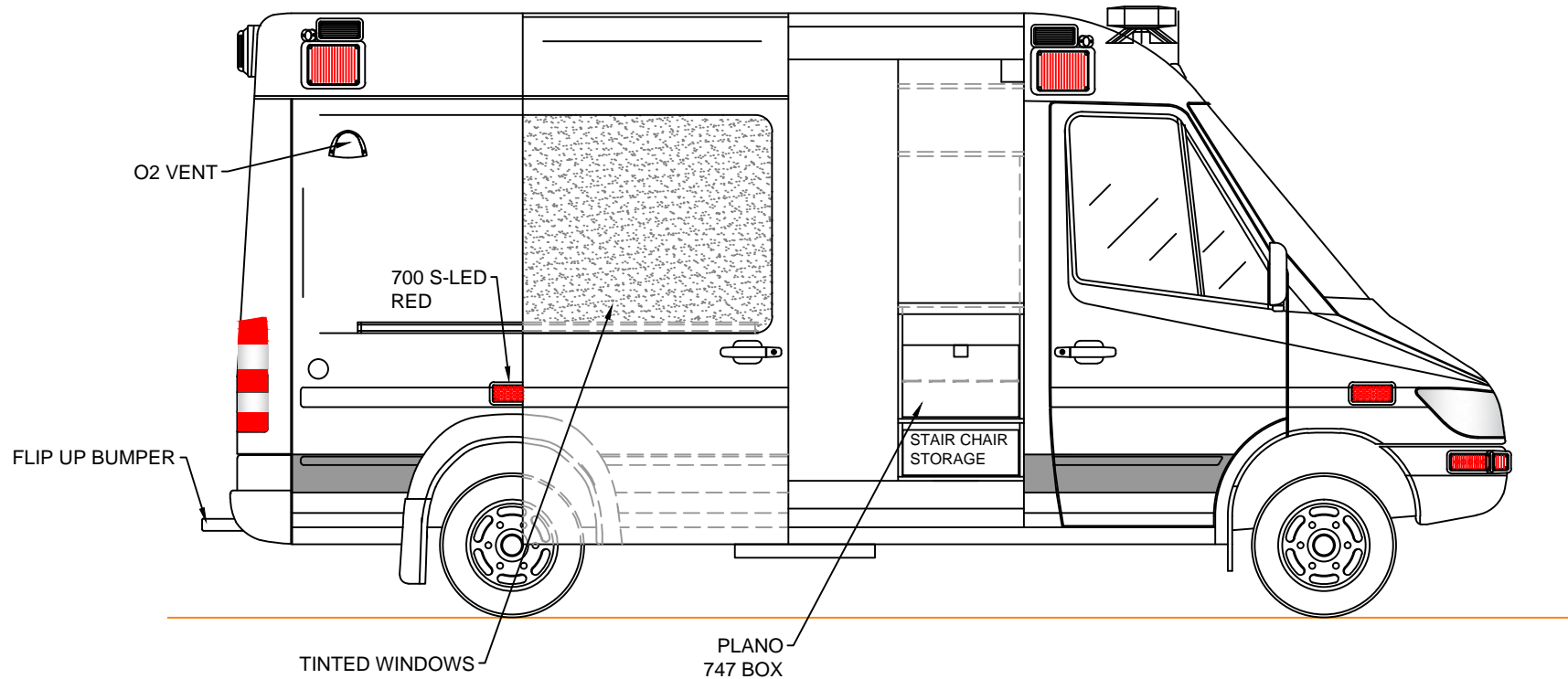

BE ADVISED THAT THESE ARE PRELIMINARY LAYOUTS INTENDED TO ILLUSTRATE DESIGN INTENT AND DIMENSIONS ARE FOR REFERENCE ONLY PRIOR TO FINAL ENGINEERING

EXTERIOR COMPARTMENT DIMENSIONS IN INCHES											
INTERIOR DIMENSIONS				JAMB OPENING		INTERIOR DIMENSIONS				JAMB OPENING	
COMPT.	HEIGHT	WIDTH	DEPTH	HEIGHT	WIDTH	COMPT.	HEIGHT	WIDTH	DEPTH	HEIGHT	WIDTH



Wheeled Coach

TYPE II SPRINTER 2018

RIGHT EXT. VIEW

DATE: 04/20/18 SCALE:

DRAWN BY: SG DWG NO: 3 / 9

CA163223

SPRINTER

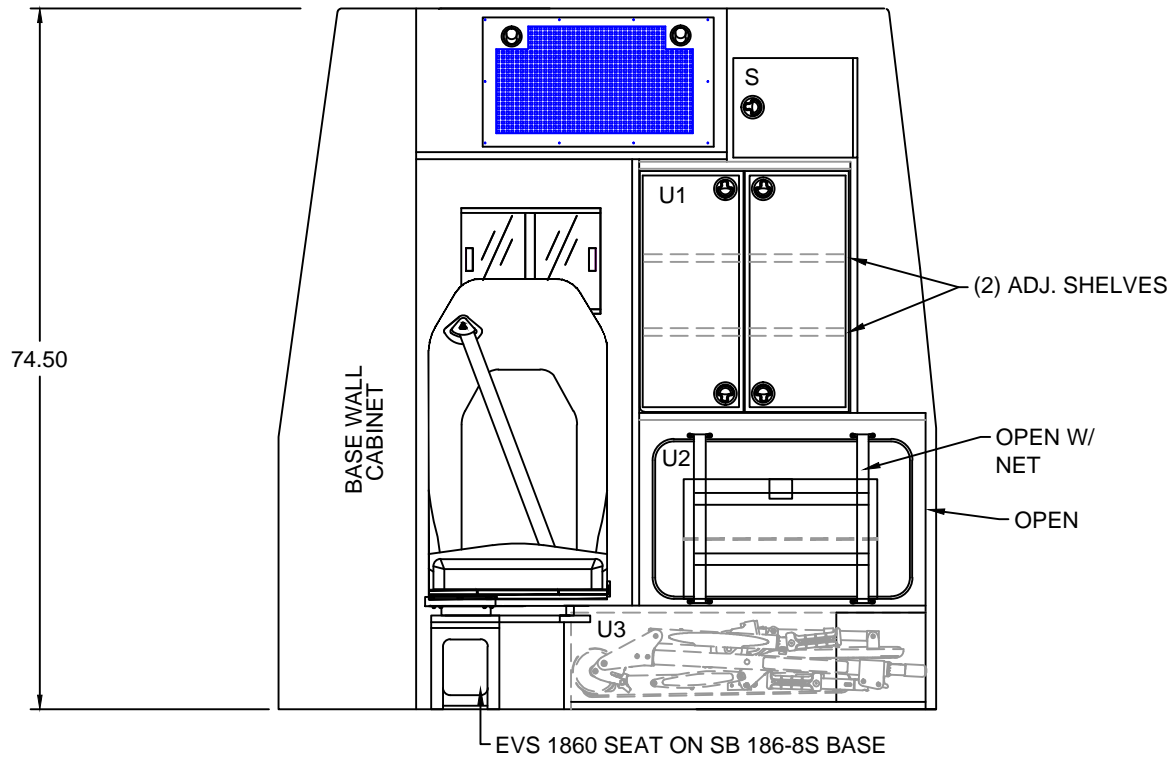

BE ADVISED THAT THESE ARE PRELIMINARY LAYOUTS INTENDED TO ILLUSTRATE DESIGN INTENT AND DIMENSIONS ARE FOR REFERENCE ONLY PRIOR TO FINAL ENGINEERING

INTERIOR CABINET DIMENSIONS IN INCHES								 TYPE II SPRINTER 2018 BULKHEAD INTERIOR	
CABINET	HEIGHT	WIDTH	DEPTH	CABINET	HEIGHT	WIDTH	DEPTH		
S	11.25	13.75	20.75						
U1	26.00	22.00	20.75						
U2	19.75	29.50	20.75						
U3	9.00	37.75	20.75						
								DATE 04/20/18	SCALE
								DRAWN BY SG	DWG NO 4 / 9

CA163223

SPRINTER

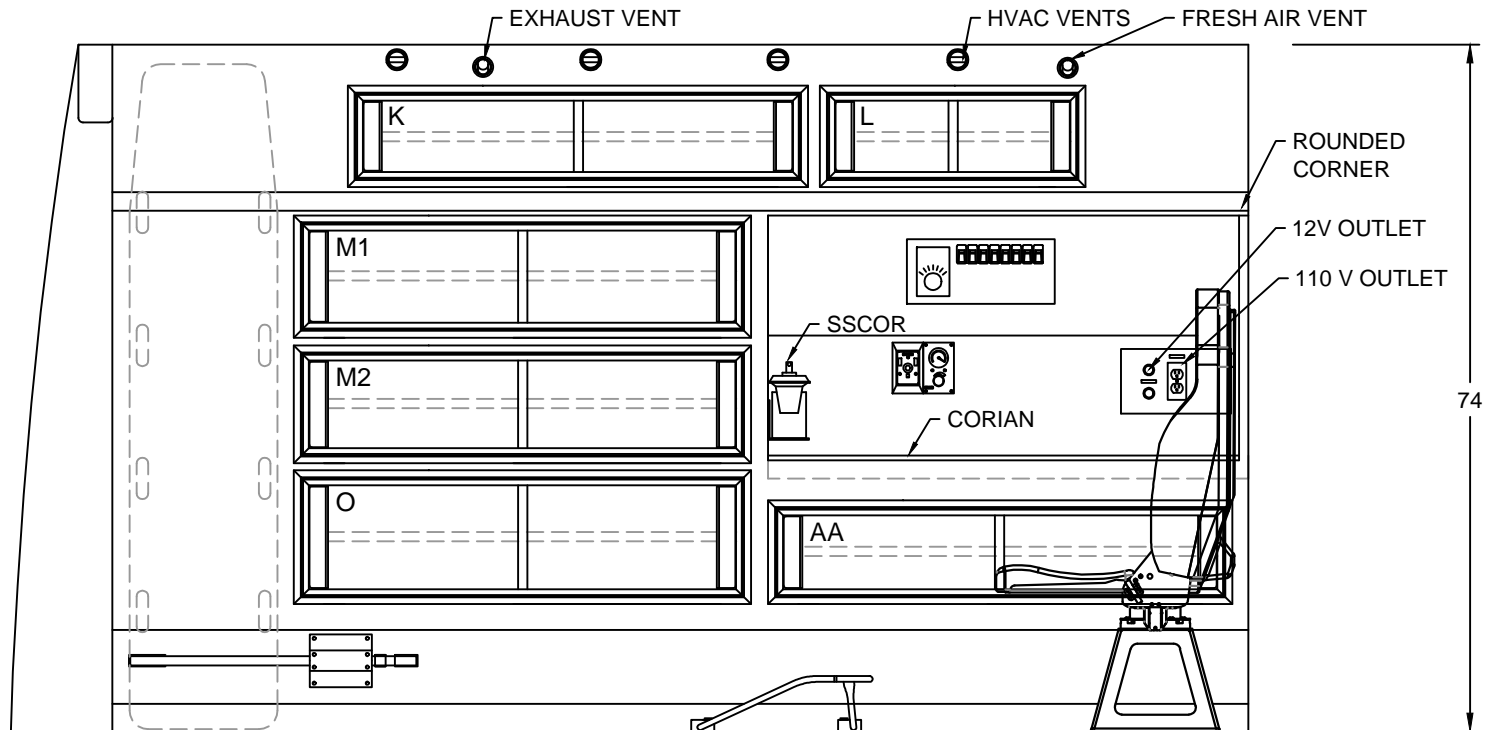

INTERIOR CABINET DIMENSIONS IN INCHES

CABINET	HEIGHT	WIDTH	DEPTH		CABINET	HEIGHT	WIDTH	DEPTH	
AA	12.00	50.25	10.75		M1	13.25	49.50	7.75	
K	9.75	49.75	7.75		M2	12.75	49.50	10.75	
L	9.75	28.75	7.75		O	14.50	49.50	10.75	



TYPE II SPRINTER 2018

LEFT INTERIOR

DATE: 04/20/18 SCALE:

DWN BY: SG DWG NO: 5 / 9

BE ADVISED THAT THESE ARE PRELIMINARY LAYOUTS INTENDED TO ILLUSTRATE DESIGN INTENT AND DIMENSIONS ARE FOR REFERENCE ONLY PRIOR TO FINAL ENGINEERING

CA163223

SPRINTER

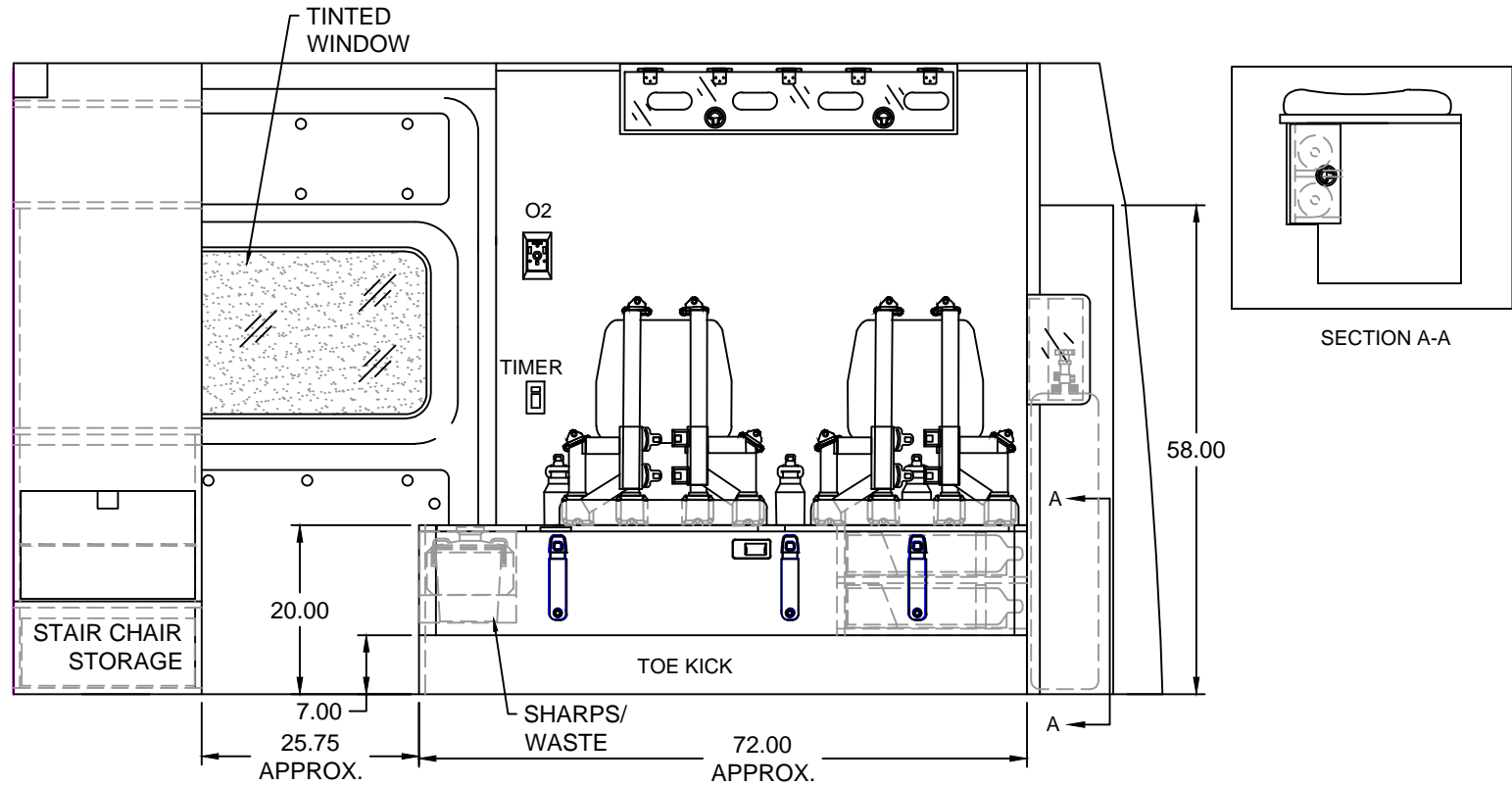

INTERIOR CABINET DIMENSIONS IN INCHES

COMPT.	HEIGHT	WIDTH	DEPTH	COMPT.	HEIGHT	WIDTH	DEPTH



TYPE II SPRINTER 2018
RIGHT INTERIOR

DATE: 04/20/18	SCALE
DWG BY: SG	DWG NO: 6 / 9

BE ADVISED THAT THESE ARE PRELIMINARY LAYOUTS INTENDED TO ILLUSTRATE DESIGN INTENT AND DIMENSIONS ARE FOR REFERENCE ONLY PRIOR TO FINAL ENGINEERING

CA163223

SPRINTER

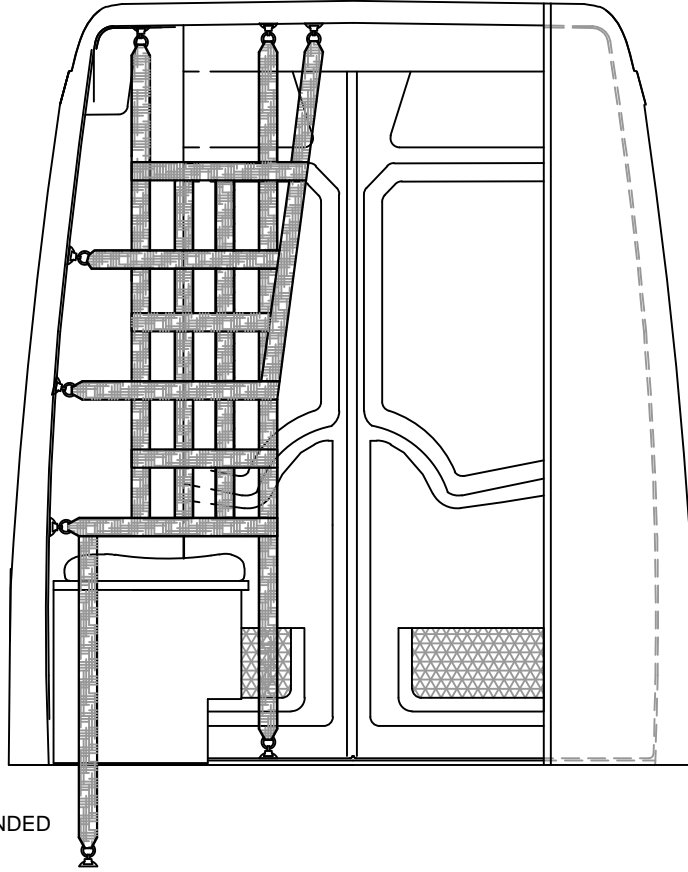

BE ADVISED THAT THESE ARE PRELIMINARY LAYOUTS INTENDED TO ILLUSTRATE DESIGN INTENT AND DIMENSIONS ARE FOR REFERENCE ONLY PRIOR TO FINAL ENGINEERING

INTERIOR CABINET DIMENSIONS IN INCHES

CABINET	HEIGHT	WIDTH	DEPTH	CABINET	HEIGHT	WIDTH	DEPTH



TYPE II SPRINTER 2018

REAR BULKHEAD

DATE: 04/20/18

SCALE

DWN BY SG

DWG NO 7 / 9

CA163223

SPRINTER

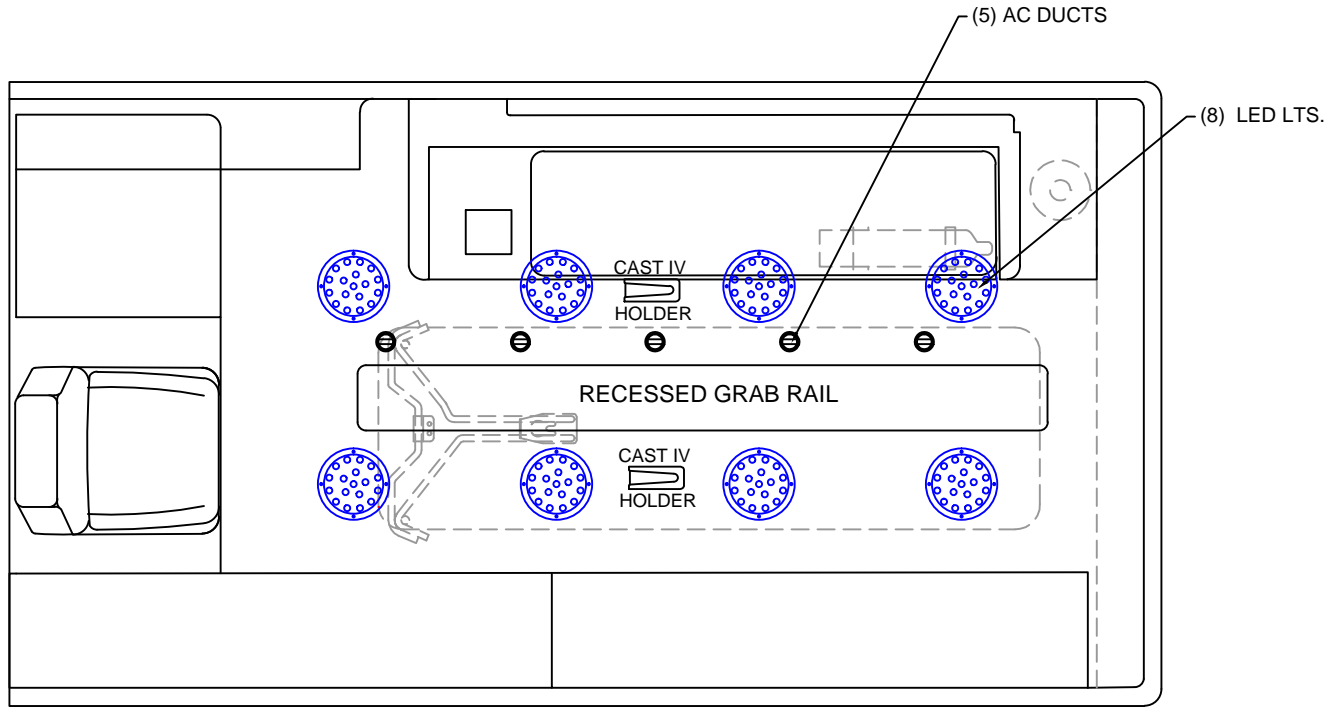

BE ADVISED THAT THESE ARE PRELIMINARY LAYOUTS INTENDED TO ILLUSTRATE DESIGN INTENT AND DIMENSIONS ARE FOR REFERENCE ONLY PRIOR TO FINAL ENGINEERING

INTERIOR CABINET DIMENSIONS IN INCHES

CABINET	HEIGHT	WIDTH	DEPTH	CABINET	HEIGHT	WIDTH	DEPTH



TYPE II SPRINTER 2018

LINER

DATE: 04/20/18

SCALE

DWN BY SG

DWG NO 8 / 9