

CA101430

MODEL 1153F

153 x 95 x 67

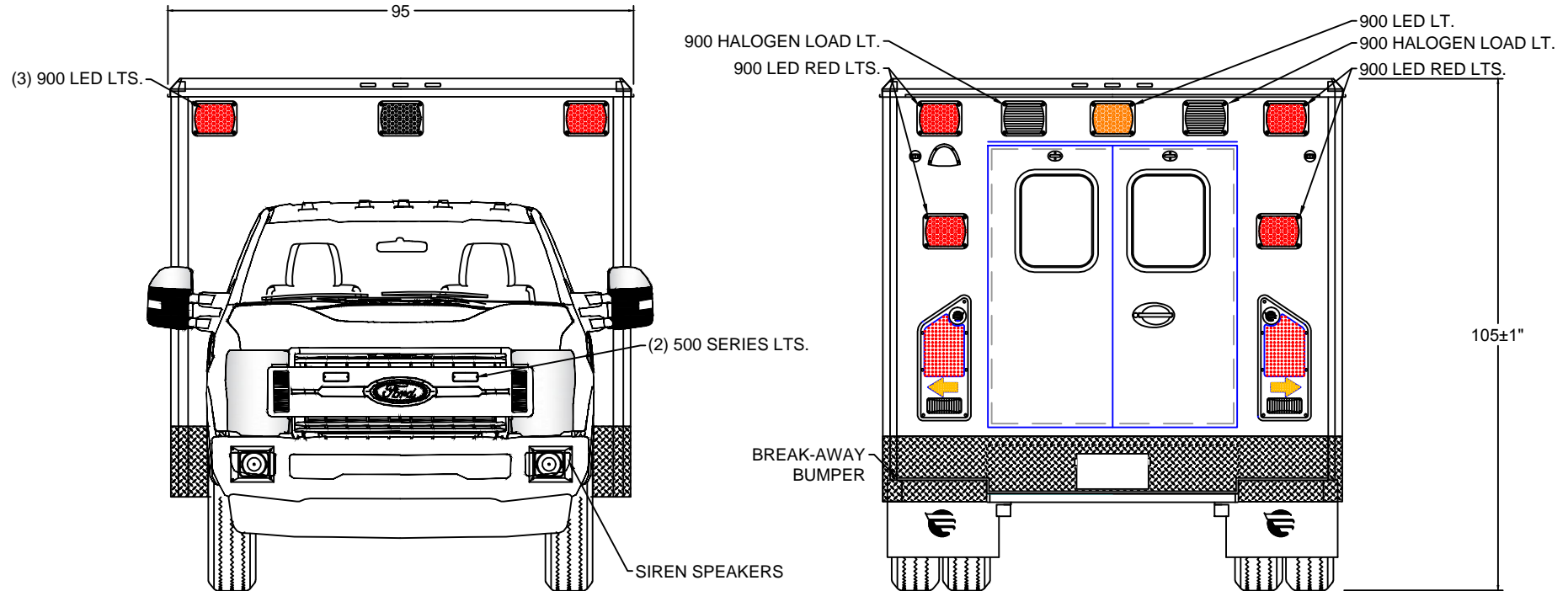

EXTERIOR COMPARTMENT DIMENSIONS IN INCHES

INTERIOR DIMENSIONS				PASS THRU		INTERIOR DIMENSIONS				JAMB OPENING	
COMPT.	HEIGHT	WIDTH	DEPTH	HEIGHT	WIDTH	COMPT.	HEIGHT	WIDTH	DEPTH	HEIGHT	WIDTH



TYPE 1 FORD 2018
FRONT / REAR
EXTERIOR VIEWS

BE ADVISED THAT THESE ARE PRELIMINARY LAYOUTS INTENDED TO ILLUSTRATE DESIGN INTENT AND DIMENSIONS ARE FOR REFERENCE ONLY PRIOR TO FINAL ENGINEERING

DATE:	04/16/18	SCALE
DWN BY:	SG	DWG NO
		1 / 9

50" AISLE

CA101430

MODEL 1153F

153 x 95 x 67

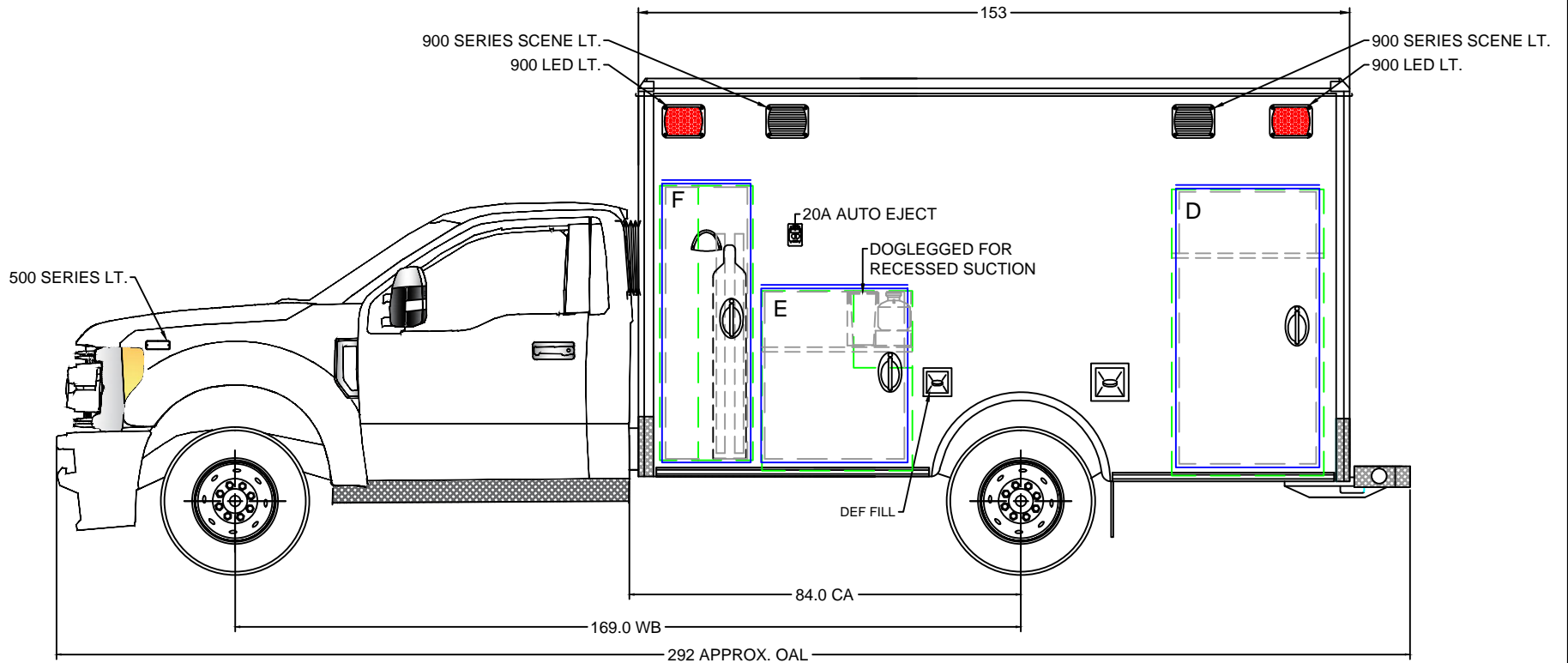

BE ADVISED THAT THESE ARE PRELIMINARY LAYOUTS INTENDED TO ILLUSTRATE DESIGN INTENT AND DIMENSIONS ARE FOR REFERENCE ONLY PRIOR TO FINAL ENGINEERING

EXTERIOR COMPARTMENT DIMENSIONS IN INCHES

INTERIOR DIMENSIONS				JAMB OPENING		INTERIOR DIMENSIONS				JAMB OPENING	
COMPT.	HEIGHT	WIDTH	DEPTH	HEIGHT	WIDTH	COMPT.	HEIGHT	WIDTH	DEPTH	HEIGHT	WIDTH
D	61.50	32.75	17.00	58.50	29.25						
E	38.75	32.25	17.00	36.00	30.00						
F	59.00	20.00	17.00	58.50	16.75						



TYPE 1 FORD 2018

LEFT EXT. VIEW

DATE 04/16/18

SCALE

DRAWN BY SG

DWG NO

2 / 9

50" AISLE

CA101430

MODEL 1153F

153 x 95 x 67

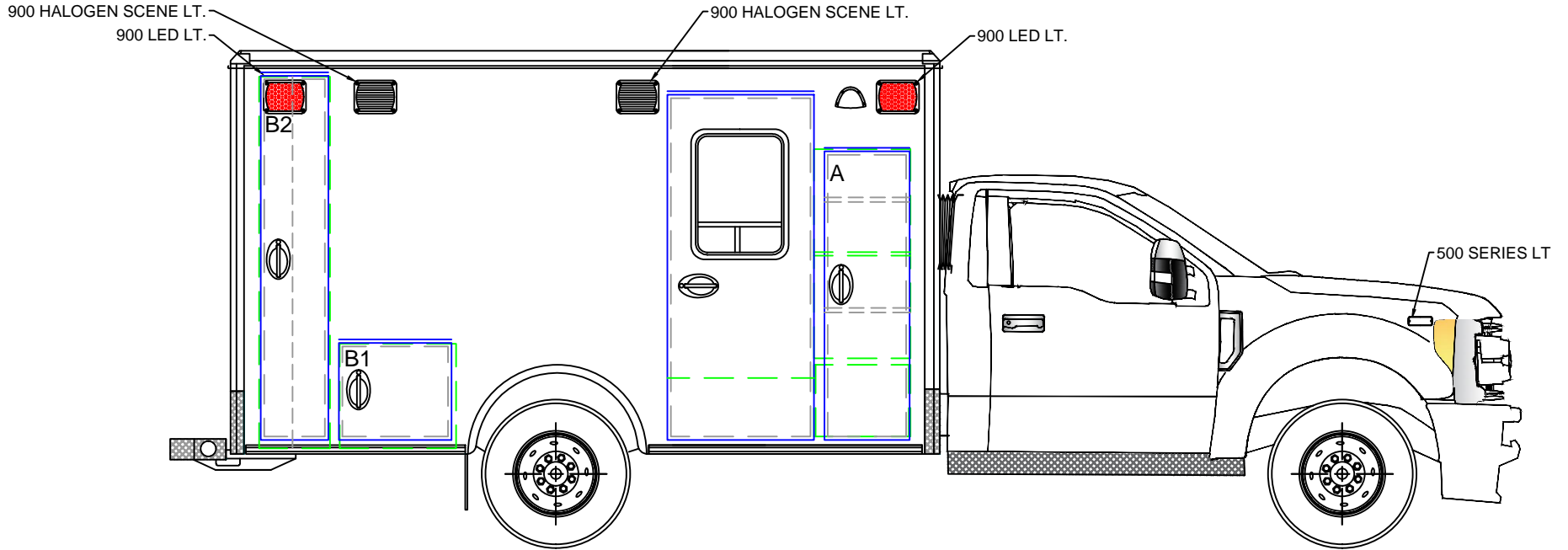

BE ADVISED THAT THESE ARE PRELIMINARY LAYOUTS INTENDED TO ILLUSTRATE DESIGN INTENT AND DIMENSIONS ARE FOR REFERENCE ONLY PRIOR TO FINAL ENGINEERING

EXTERIOR COMPARTMENT DIMENSIONS IN INCHES													
INTERIOR DIMENSIONS				JAMB OPENING		INTERIOR DIMENSIONS				JAMB OPENING			TYPE 1 FORD 2018 RIGHT EXT. VIEW
COMPT.	HEIGHT	WIDTH	DEPTH	HEIGHT	WIDTH	COMPT.	HEIGHT	WIDTH	DEPTH	HEIGHT	WIDTH	DATE	
A	45.00	20.75	33.50	60.50	16.75							04/16/18	
LOWER-A	15.50	20.00	19.00									DRAWN BY	DWG NO
B1	22.50	25.00	17.00	19.25	22.75							SG	3 / 9
B2	80.00	15.25	18.50	76.75	13.00								
50" AISLE													

CA101430

MODEL 1153F

153 x 95 x 67

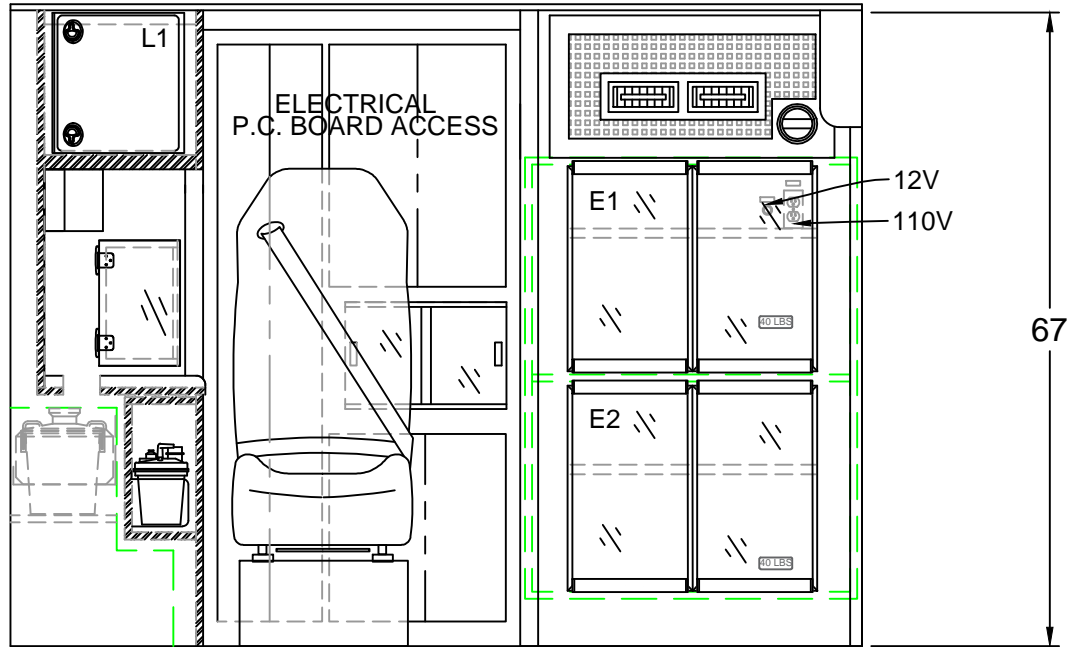

BE ADVISED THAT THESE ARE PRELIMINARY LAYOUTS INTENDED TO ILLUSTRATE DESIGN INTENT AND DIMENSIONS ARE FOR REFERENCE ONLY PRIOR TO FINAL ENGINEERING

CABINET WEIGHT RATINGS:
NON-RESTOCKING = 40 LBS.
RESTOCKING = 30 LBS.

INTERIOR CABINET DIMENSIONS IN INCHES

CABINET	HEIGHT	WIDTH	DEPTH	CABINET	HEIGHT	WIDTH	DEPTH
E1	22.00	33.50	20.75				
E2	22.00	33.50	20.75				



TYPE 1 FORD 2018
BULKHEAD INTERIOR

DATE 04/16/18

SCALE

DRAWN BY SG

DWG NO 4 / 9

50" AISLE

CA101430

MODEL 1153F

153 x 95 x 67

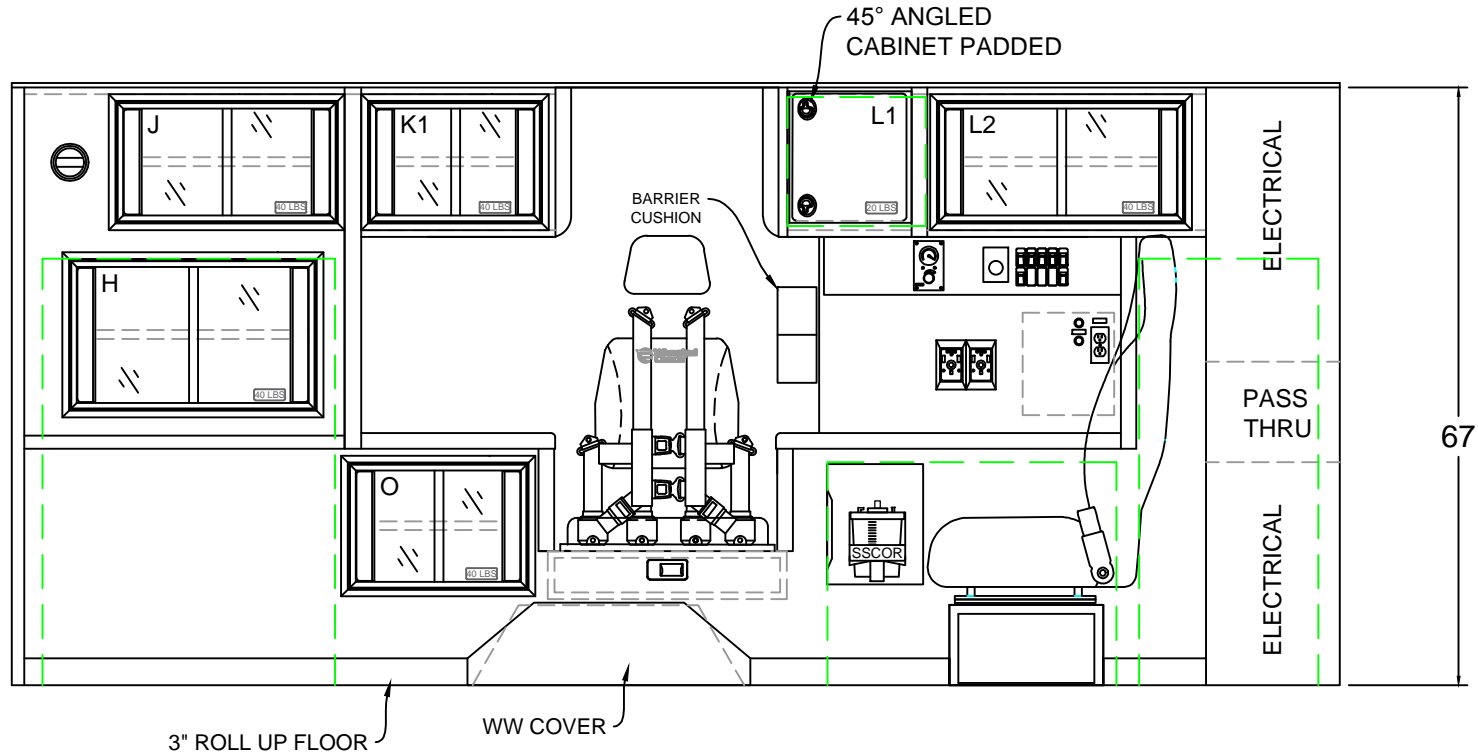

INTERIOR CABINET DIMENSIONS IN INCHES

CABINET	HEIGHT	WIDTH	DEPTH		CABINET	HEIGHT	WIDTH	DEPTH	
H	17.50	25.50	IS/OS		O	14.25	20.25	17.50	
J	13.75	25.00	17.50						
K	13.75	19.50	12.00						
L1	13.25	10.00	15.25						
L2	13.75	27.75	15.25						



TYPE 1 FORD 2018

LEFT INTERIOR

DATE: 04/16/18 SCALE:
 DWN BY: SG DWG NO: 5 / 9

50" AISLE

CABINET WEIGHT RATINGS:
 NON-RESTOCKING = 40 LBS.
 RESTOCKING = 30 LBS.

BE ADVISED THAT THESE ARE PRELIMINARY LAYOUTS INTENDED TO ILLUSTRATE DESIGN INTENT AND DIMENSIONS ARE FOR REFERENCE ONLY PRIOR TO FINAL ENGINEERING

CA101430

MODEL 1153F

153 x 95 x 67

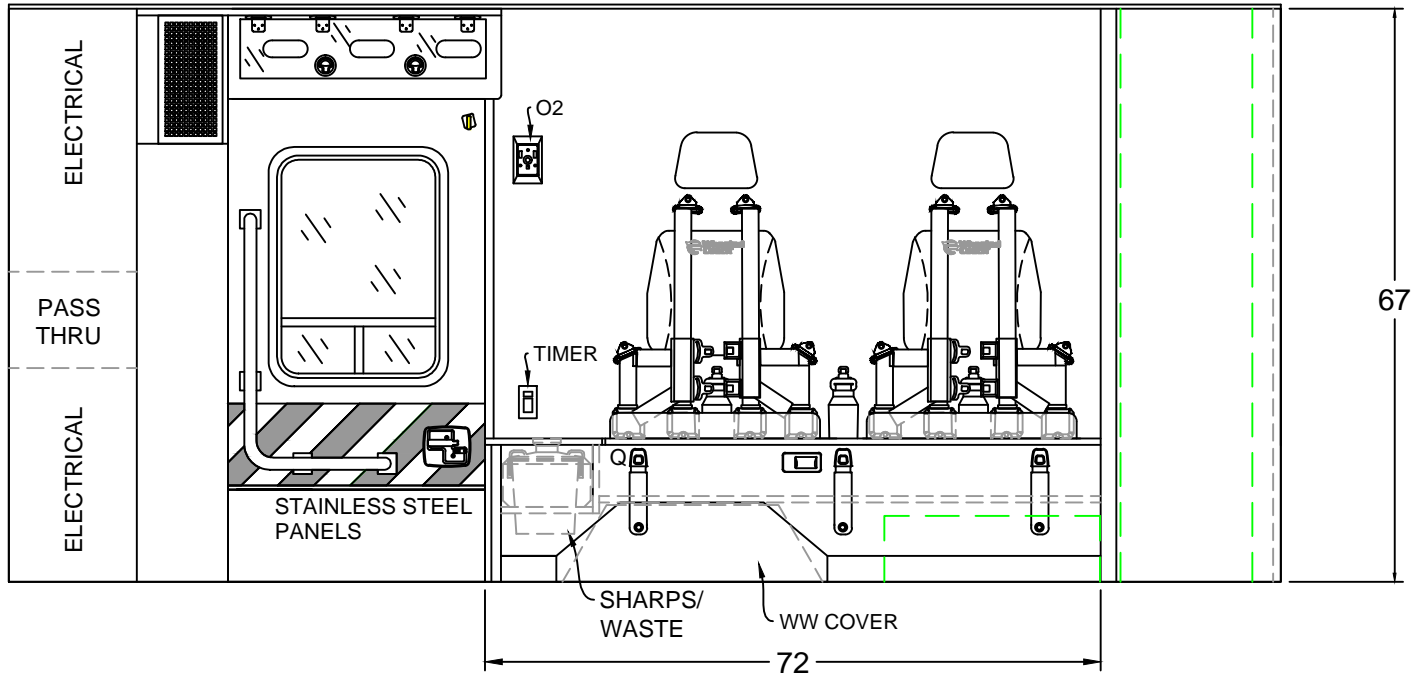

INTERIOR CABINET DIMENSIONS IN INCHES

COMPT.	HEIGHT	WIDTH	DEPTH	COMPT.	HEIGHT	WIDTH	DEPTH
Q	6.00	59.75	16.75				



TYPE 1 FORD 2018
RIGHT INTERIOR

DATE: 04/16/18 SCALE:
DWN BY: SG DWG NO: 6 / 9

50" AISLE

CABINET WEIGHT RATINGS:
NON-RESTOCKING = 40 LBS.
RESTOCKING = 30 LBS.

BE ADVISED THAT THESE ARE PRELIMINARY LAYOUTS INTENDED TO ILLUSTRATE DESIGN INTENT AND DIMENSIONS ARE FOR REFERENCE ONLY PRIOR TO FINAL ENGINEERING

CA101430

MODEL 1153F

153 x 95 x 67

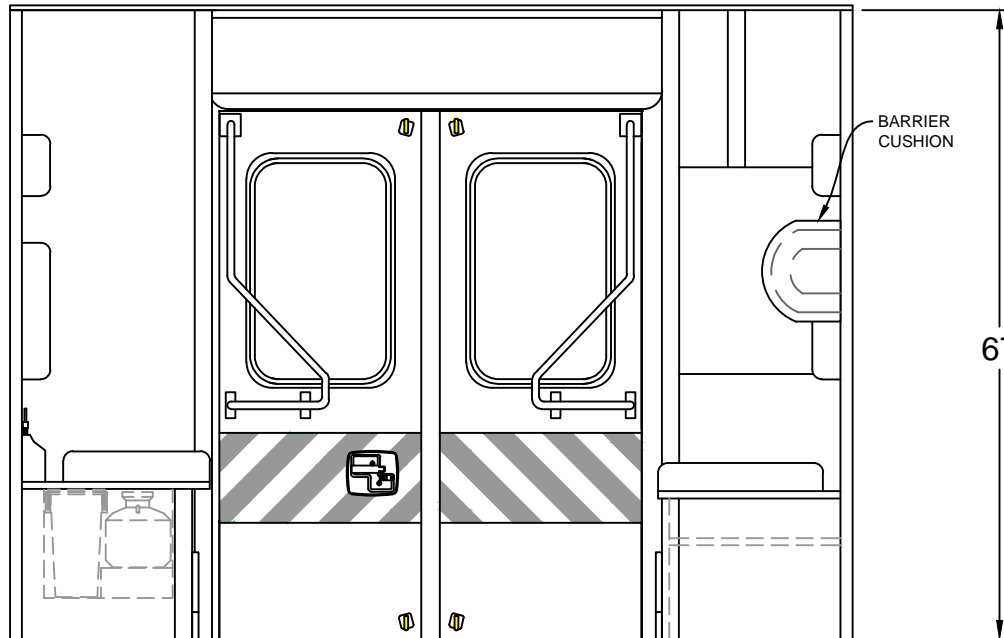

INTERIOR CABINET DIMENSIONS IN INCHES



TYPE 1 FORD 2018

REAR BULKHEAD INTERIOR

DATE: 04/16/18

SCALE

DNW BY

SG

DNW NO

7 / 9

COMPT.	HEIGHT	WIDTH	DEPTH		COMPT.	HEIGHT	WIDTH	DEPTH	

50" AISLE

CABINET WEIGHT RATINGS:
NON-RESTOCKING = 40 LBS.
RESTOCKING = 30 LBS.

BE ADVISED THAT THESE ARE PRELIMINARY LAYOUTS INTENDED TO ILLUSTRATE DESIGN INTENT AND DIMENSIONS ARE FOR REFERENCE ONLY PRIOR TO FINAL ENGINEERING

CA101430

MODEL 1153F

153 x 95 x 67

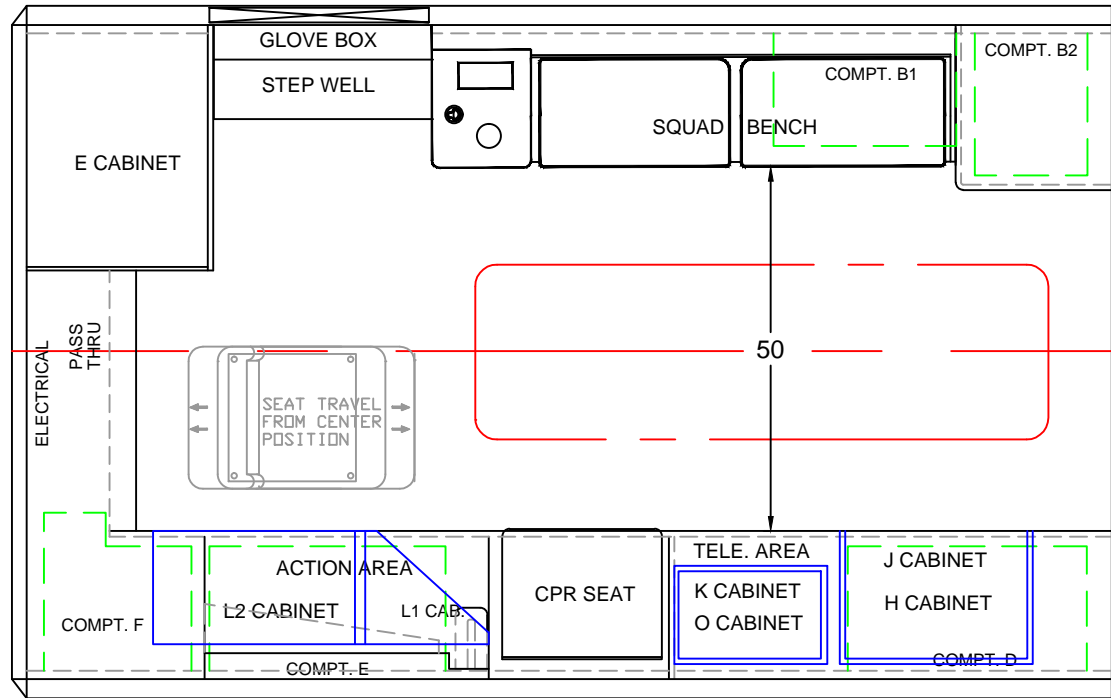

BE ADVISED THAT THESE ARE PRELIMINARY LAYOUTS INTENDED TO ILLUSTRATE DESIGN INTENT AND DIMENSIONS ARE FOR REFERENCE ONLY PRIOR TO FINAL ENGINEERING

INTERIOR CABINET DIMENSIONS IN INCHES

CABINET	HEIGHT	WIDTH	DEPTH	CABINET	HEIGHT	WIDTH	DEPTH



TYPE 1 FORD 2018
FLOOR PLAN

DATE: 04/16/18 SCALE
DWN BY: SG DWG NO: 8 / 9

50" AISLE

CA101430

MODEL 1153F

153 x 95 x 67

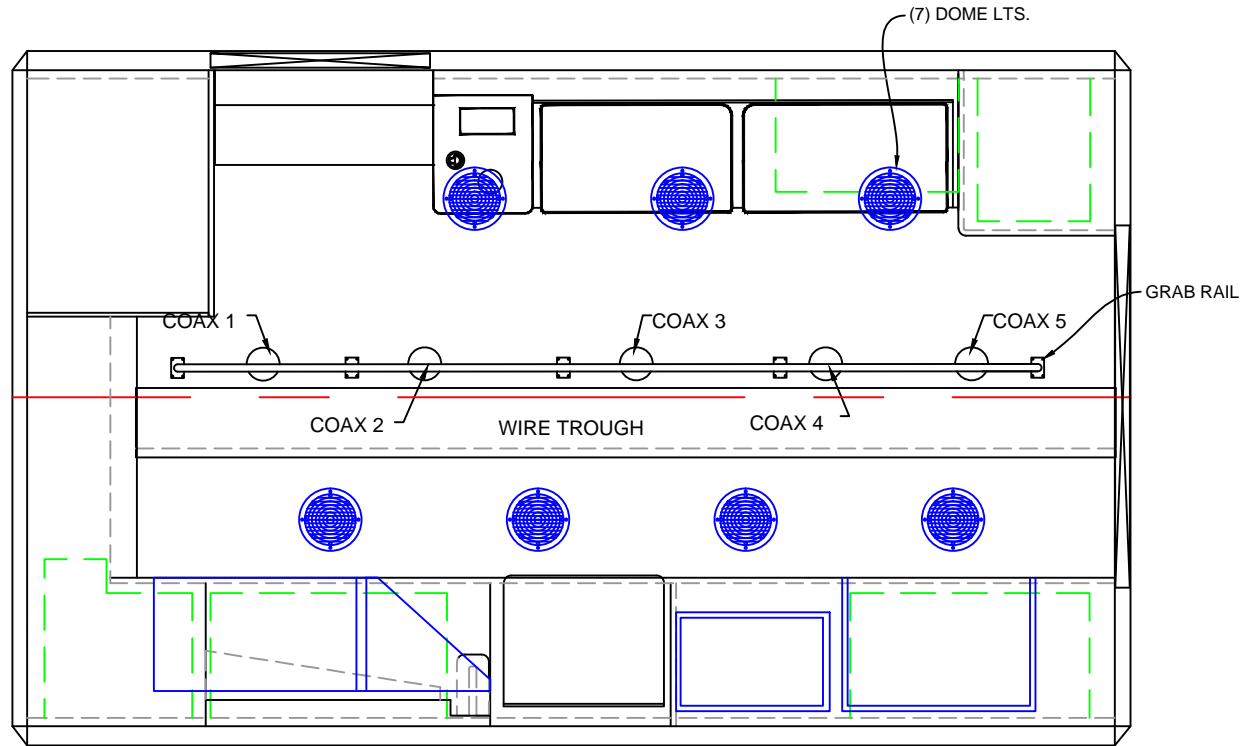

BE ADVISED THAT THESE ARE PRELIMINARY LAYOUTS INTENDED TO ILLUSTRATE DESIGN INTENT AND DIMENSIONS ARE FOR REFERENCE ONLY PRIOR TO FINAL ENGINEERING

INTERIOR CABINET DIMENSIONS IN INCHES

CABINET	HEIGHT	WIDTH	DEPTH	CABINET	HEIGHT	WIDTH	DEPTH



TYPE 1 FORD 2018

LINER

DATE: 04/16/18

SCALE

DWN BY SG

DWG NO 9 / 9

50" AISLE