

CA161785

TRANSIT MID ROOF

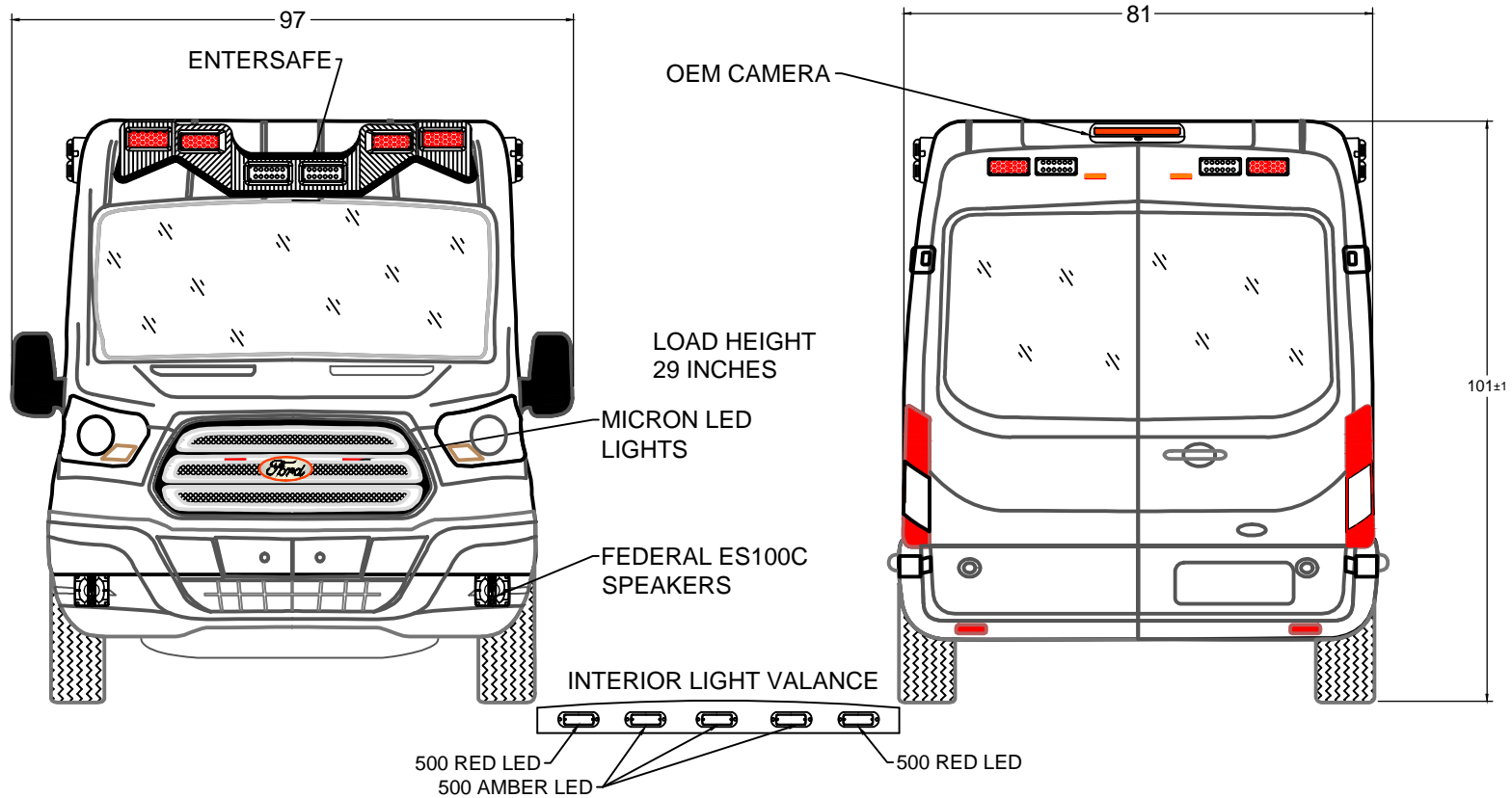

EXTERIOR COMPARTMENT DIMENSIONS IN INCHES

INTERIOR DIMENSIONS				PASS THRU		INTERIOR DIMENSIONS				JAMB OPENING	
COMPT.	HEIGHT	WIDTH	DEPTH	HEIGHT	WIDTH	COMPT.	HEIGHT	WIDTH	DEPTH	HEIGHT	WIDTH



TRANSIT MID HEIGHT
FRONT / REAR
EXTERIOR VIEWS

BE ADVISED THAT THESE ARE PRELIMINARY LAYOUTS INTENDED TO ILLUSTRATE DESIGN INTENT AND DIMENSIONS ARE FOR REFERENCE ONLY PRIOR TO FINAL ENGINEERING

DATE:	01/29/18	SCALE
DWN BY	SG	DWG NO 1 / 7

CA161785

TRANSIT MID ROOF

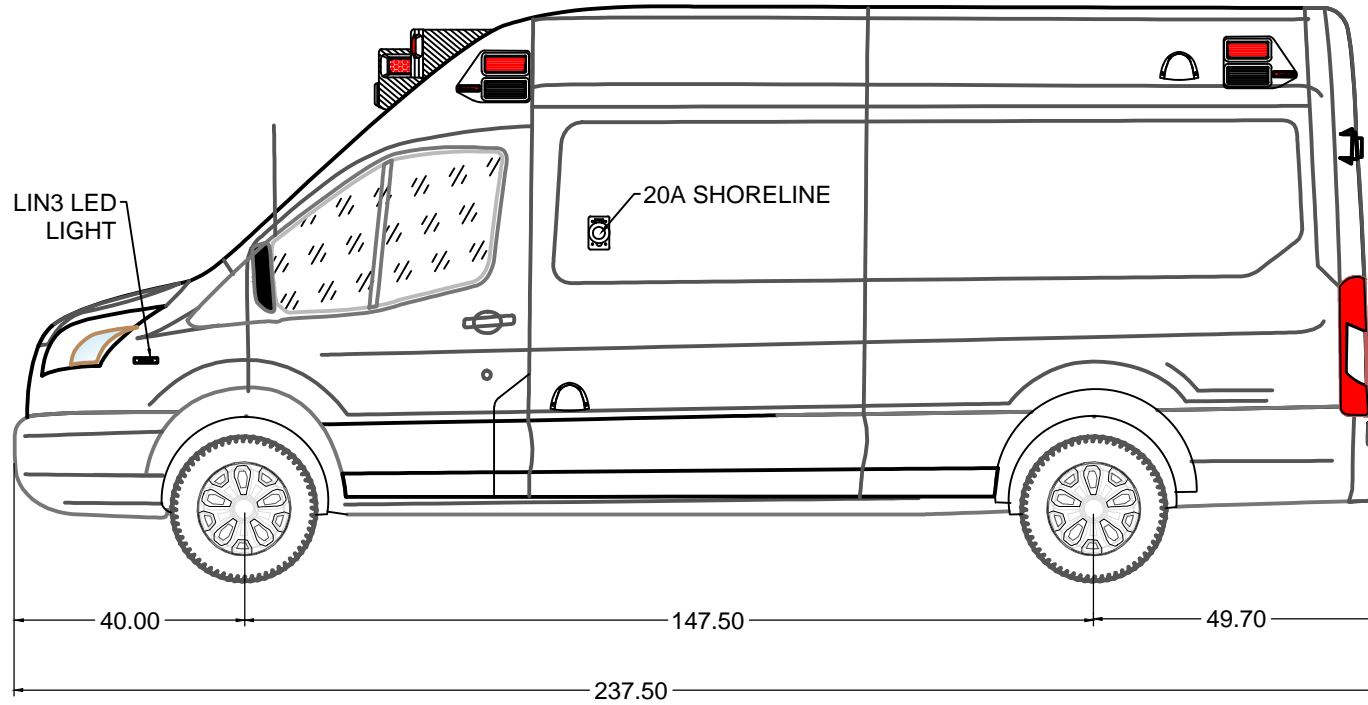

BE ADVISED THAT THESE ARE PRELIMINARY LAYOUTS INTENDED TO ILLUSTRATE DESIGN INTENT AND DIMENSIONS ARE FOR REFERENCE ONLY PRIOR TO FINAL ENGINEERING

EXTERIOR COMPARTMENT DIMENSIONS IN INCHES													
INTERIOR DIMENSIONS				JAMB OPENING		INTERIOR DIMENSIONS				JAMB OPENING			
COMPT.	HEIGHT	WIDTH	DEPTH	HEIGHT	WIDTH	COMPT.	HEIGHT	WIDTH	DEPTH	HEIGHT	WIDTH		
													TRANSIT MID HEIGHT
													LEFT EXT. VIEW
													DATE 01/29/18
													SCALE
													DRAWN BY SG
													DWG NO 2 / 7

CA161785

TRANSIT MID ROOF

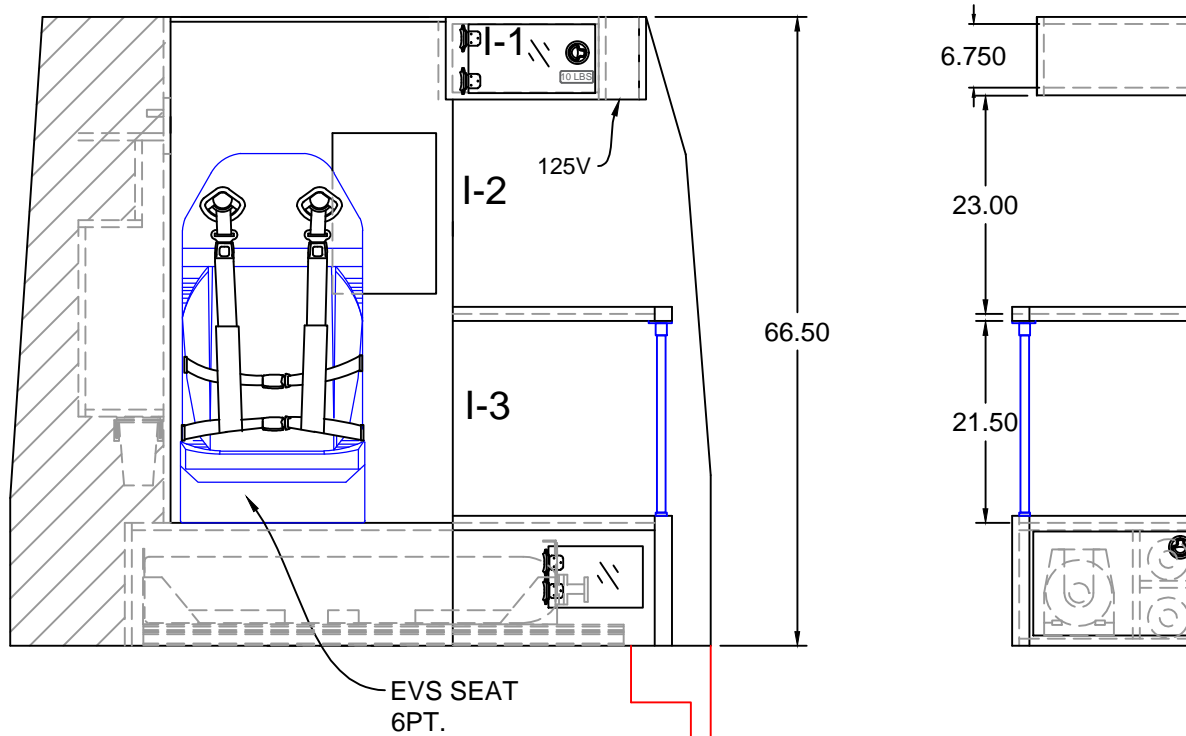

BE ADVISED THAT THESE ARE PRELIMINARY LAYOUTS INTENDED TO ILLUSTRATE DESIGN INTENT AND DIMENSIONS ARE FOR REFERENCE ONLY PRIOR TO FINAL ENGINEERING

INTERIOR CABINET DIMENSIONS IN INCHES								
CABINET	HEIGHT	WIDTH	DEPTH	CABINET	HEIGHT	WIDTH	DEPTH	
I-1	8.75	15.75	16.25					TRANSIT MID HEIGHT BULKHEAD INTERIOR
I-2	23.00	22.50	18.75					
I-3	21.50	22.50	18.75					
								DATE 01/29/18 SCALE
								DRAWN BY SG DWG NO 4 / 7

CA161785

TRANSIT MID ROOF

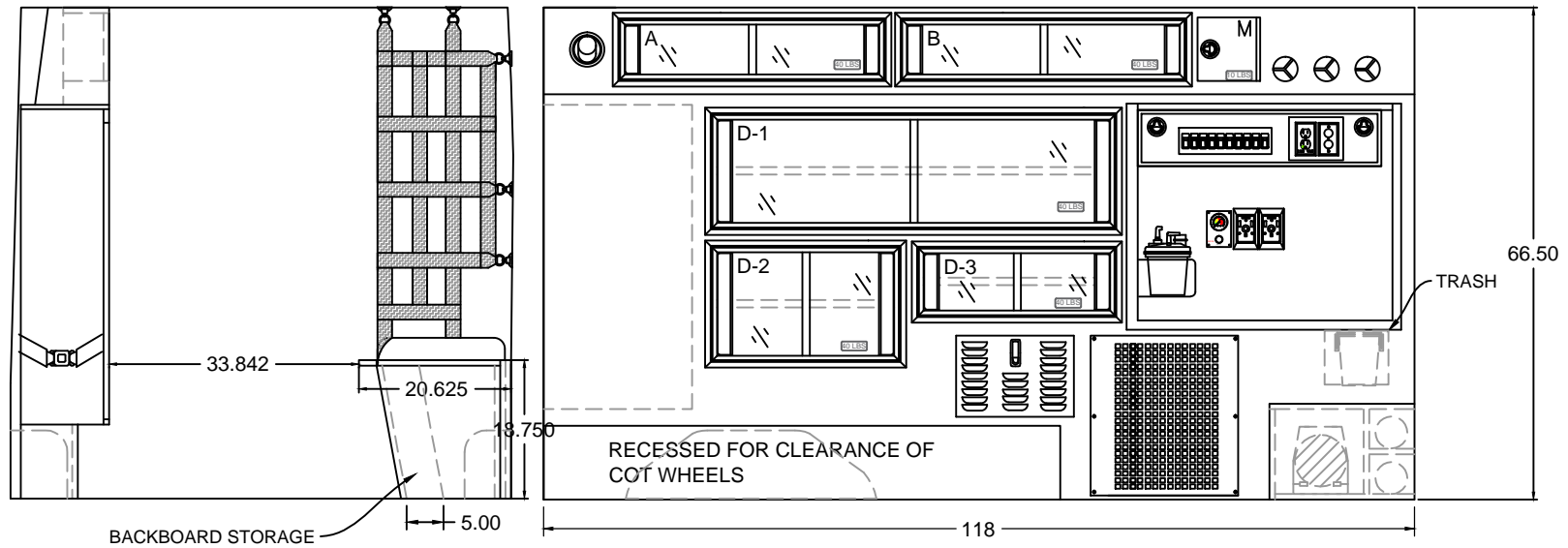

INTERIOR CABINET DIMENSIONS IN INCHES

CABINET	HEIGHT	WIDTH	DEPTH		CABINET	HEIGHT	WIDTH	DEPTH	
A	8.50	37.75	5.25		D3	10.75	28.50	9.25	
B	8.50	40.25	5.25						
M	8.50	8.50	5.25						
D1	16.25	56.50	9.25						
D2	17.25	26.50	9.25						



TRANSIT MID HEIGHT

LEFT INTERIOR

DATE:	01/29/18	SCALE:	
DWN BY:	SG	DWG NO:	5 / 7

BE ADVISED THAT THESE ARE PRELIMINARY LAYOUTS INTENDED TO ILLUSTRATE DESIGN INTENT AND DIMENSIONS ARE FOR REFERENCE ONLY PRIOR TO FINAL ENGINEERING

CA161785

TRANSIT MID ROOF

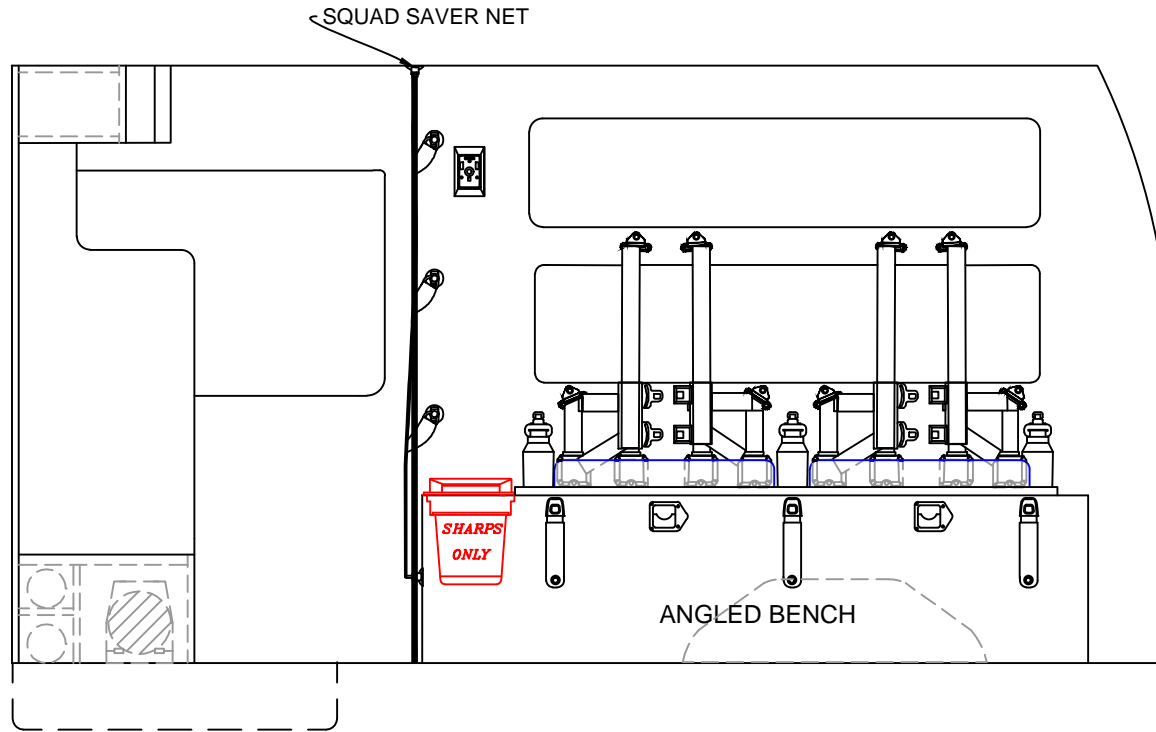

INTERIOR CABINET DIMENSIONS IN INCHES

COMPT.	HEIGHT	WIDTH	DEPTH		COMPT.	HEIGHT	WIDTH	DEPTH	



TRANSIT MID HEIGHT
RIGHT INTERIOR

DATE: 01/29/18 SCALE

DWG BY: SG DWG NO: 6 / 7

BE ADVISED THAT THESE ARE PRELIMINARY LAYOUTS INTENDED TO ILLUSTRATE DESIGN INTENT AND DIMENSIONS ARE FOR REFERENCE ONLY PRIOR TO FINAL ENGINEERING

CA161785

TRANSIT MID ROOF

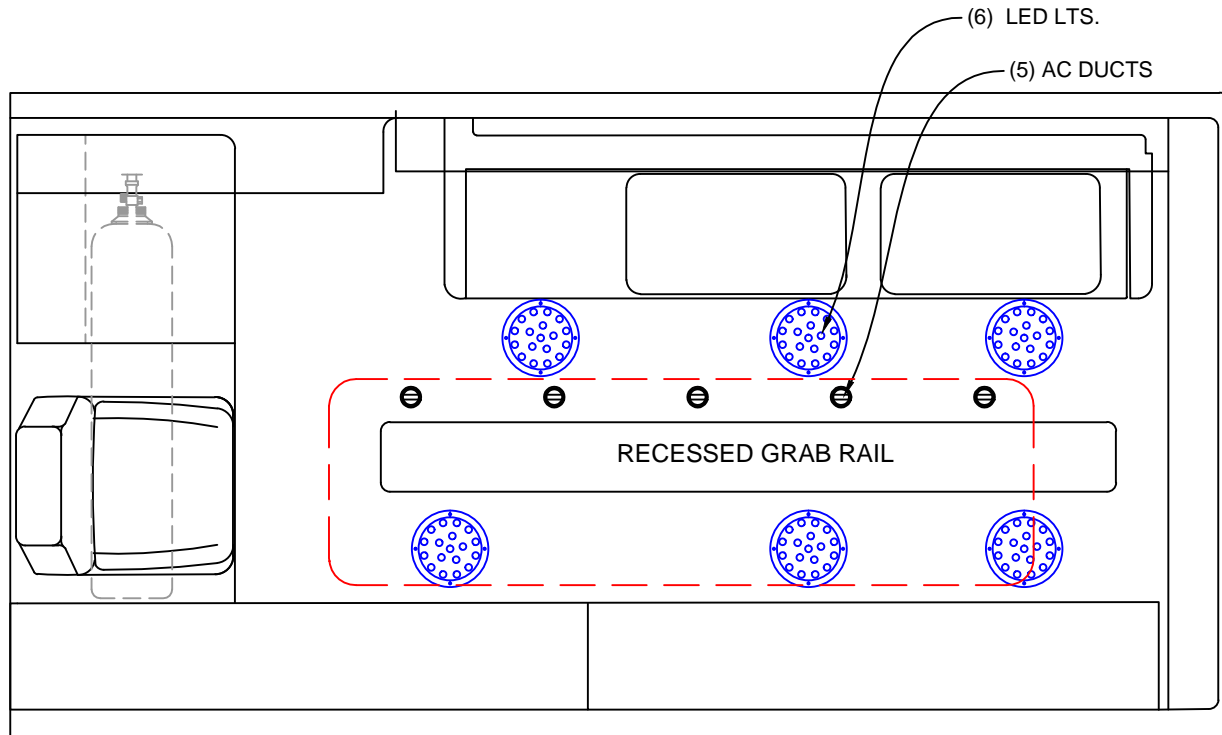

BE ADVISED THAT THESE ARE PRELIMINARY LAYOUTS INTENDED TO ILLUSTRATE DESIGN INTENT AND DIMENSIONS ARE FOR REFERENCE ONLY PRIOR TO FINAL ENGINEERING

INTERIOR CABINET DIMENSIONS IN INCHES

CABINET	HEIGHT	WIDTH	DEPTH	CABINET	HEIGHT	WIDTH	DEPTH



TRANSIT MID HEIGHT
LINER

DATE: 01/29/18 SCALE:
DWN BY: SG DWG NO: 7 / 7