

CA166000

MODEL 9170C

170 x 95 x 72

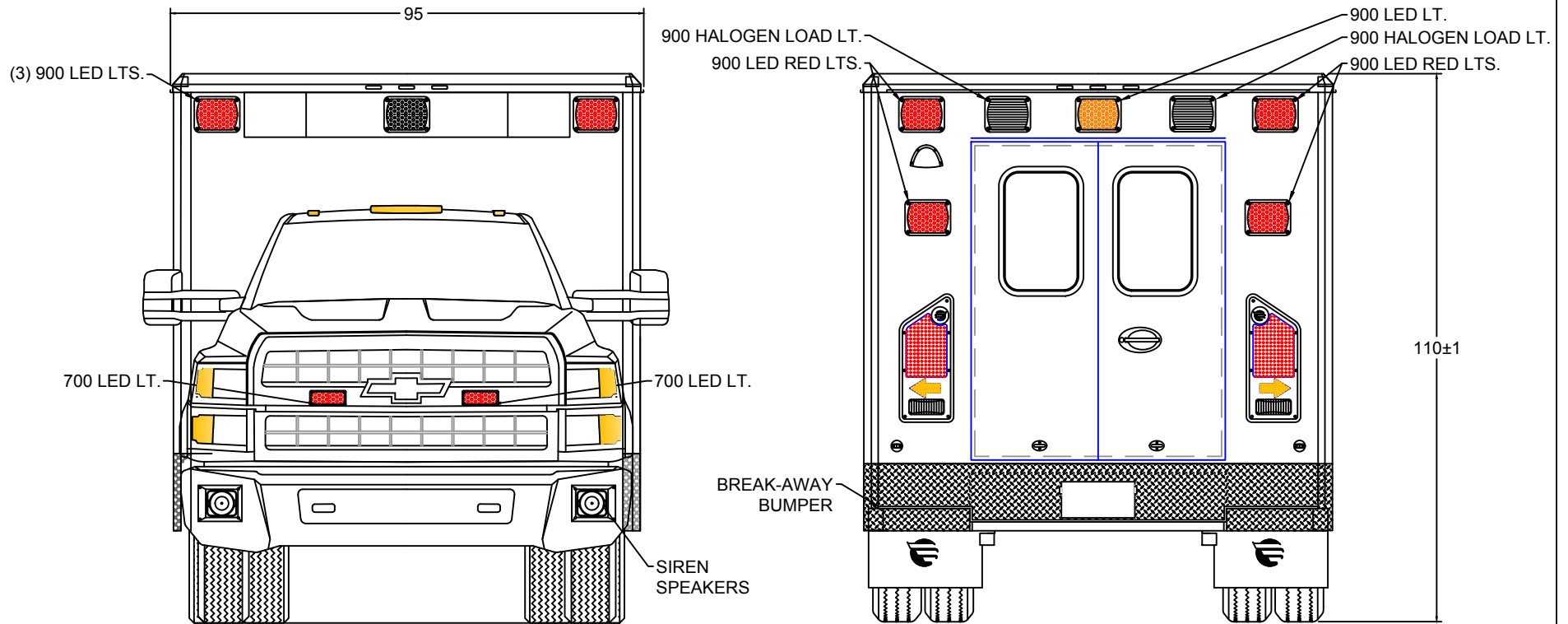

EXTERIOR COMPARTMENT DIMENSIONS IN INCHES

INTERIOR DIMENSIONS				PASS THRU		INTERIOR DIMENSIONS				JAMB OPENING	
COMPT.	HEIGHT	WIDTH	DEPTH	HEIGHT	WIDTH	COMPT.	HEIGHT	WIDTH	DEPTH	HEIGHT	WIDTH



TYPE 9 CHEVY 2021  
FRONT / REAR  
EXTERIOR VIEWS

BE ADVISED THAT THESE ARE PRELIMINARY LAYOUTS INTENDED TO ILLUSTRATE DESIGN INTENT AND DIMENSIONS ARE FOR REFERENCE ONLY PRIOR TO FINAL ENGINEERING

DATE:	2/15/21	SCALE	
DWN BY	AP	DWG NO	1 / 9

44" AISLE

CA166000

MODEL 9170C

170 x 95 x 72

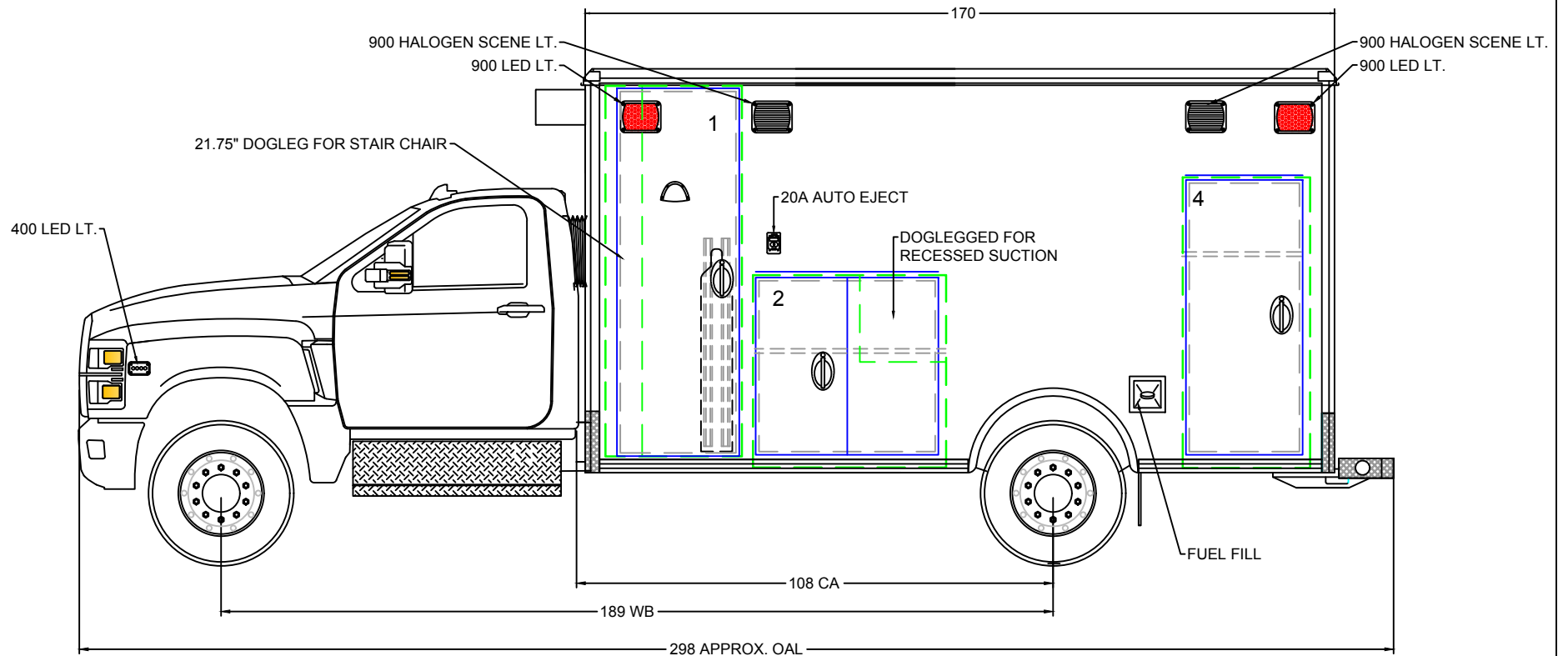

BE ADVISED THAT THESE ARE PRELIMINARY LAYOUTS INTENDED TO ILLUSTRATE DESIGN INTENT AND DIMENSIONS ARE FOR REFERENCE ONLY PRIOR TO FINAL ENGINEERING

EXTERIOR COMPARTMENT DIMENSIONS IN INCHES

INTERIOR DIMENSIONS				JAMB OPENING		INTERIOR DIMENSIONS				JAMB OPENING	
COMPT.	HEIGHT	WIDTH	DEPTH	HEIGHT	WIDTH	COMPT.	HEIGHT	WIDTH	DEPTH	HEIGHT	WIDTH
4	65.75	28.75	19.50	62.75	26.50						
2	43.50	43.75	19.75	40.50	41.50						
1	84.00	30.75	19.75	83.50	27.75						



TYPE 9 CHEVY 2021

LEFT EXT. VIEW

DATE	2/15/21	SCALE	
DRAWN BY	AP	DWG NO	2 / 9

44" AISLE

CA166000

MODEL 9170C

170 x 95 x 72

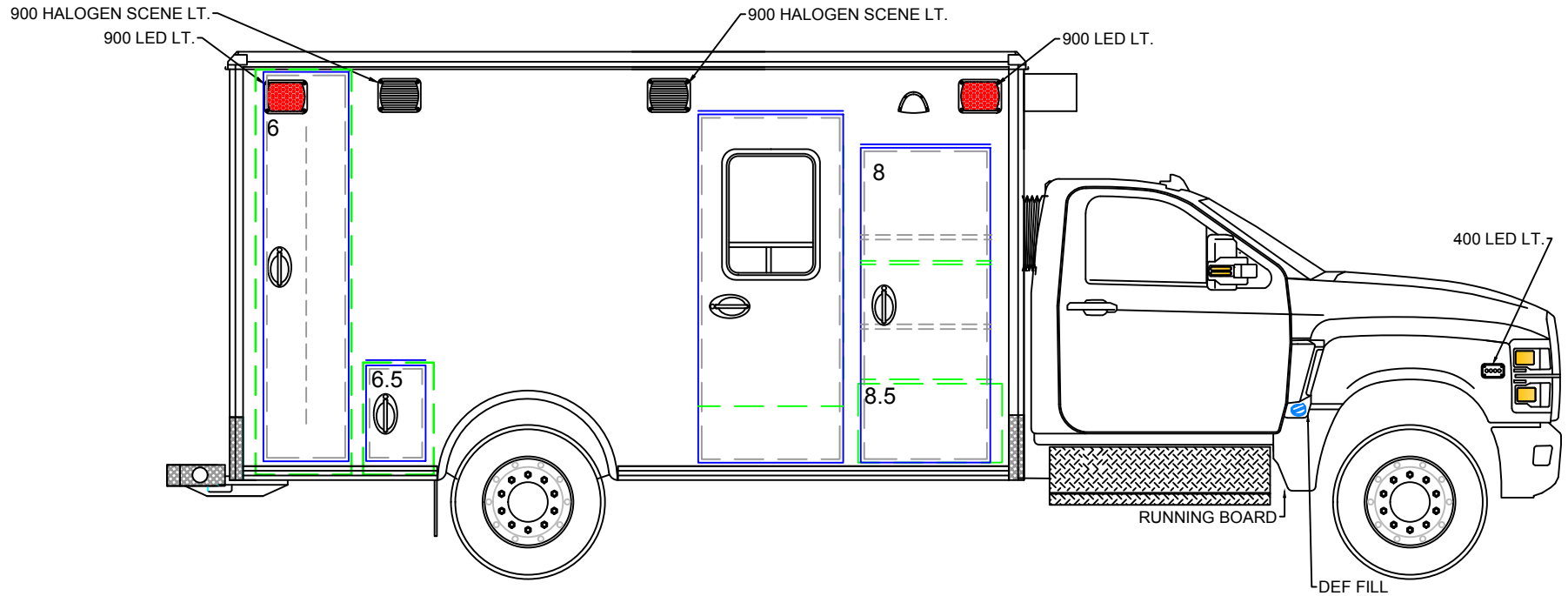

BE ADVISED THAT THESE ARE PRELIMINARY LAYOUTS INTENDED TO ILLUSTRATE DESIGN INTENT AND DIMENSIONS ARE FOR REFERENCE ONLY PRIOR TO FINAL ENGINEERING

EXTERIOR COMPARTMENT DIMENSIONS IN INCHES

INTERIOR DIMENSIONS				JAMB OPENING		INTERIOR DIMENSIONS				JAMB OPENING	
COMPT.	HEIGHT	WIDTH	DEPTH	HEIGHT	WIDTH	COMPT.	HEIGHT	WIDTH	DEPTH	HEIGHT	WIDTH
8				67.25	27.75						
8.5	16.75	30.75	20.50								
6.5	23.75	15.00	19.75	20.75	12.75						
6	86.50	20.50	19.75	83.50	18.25						



TYPE 9 CHEVY 2021

RIGHT EXT. VIEW

DATE	2/15/21	SCALE	
DRAWN BY	AP	DWG NO	3 / 9

44" AISLE

CA166000

MODEL 9170C

170 x 95 x 72

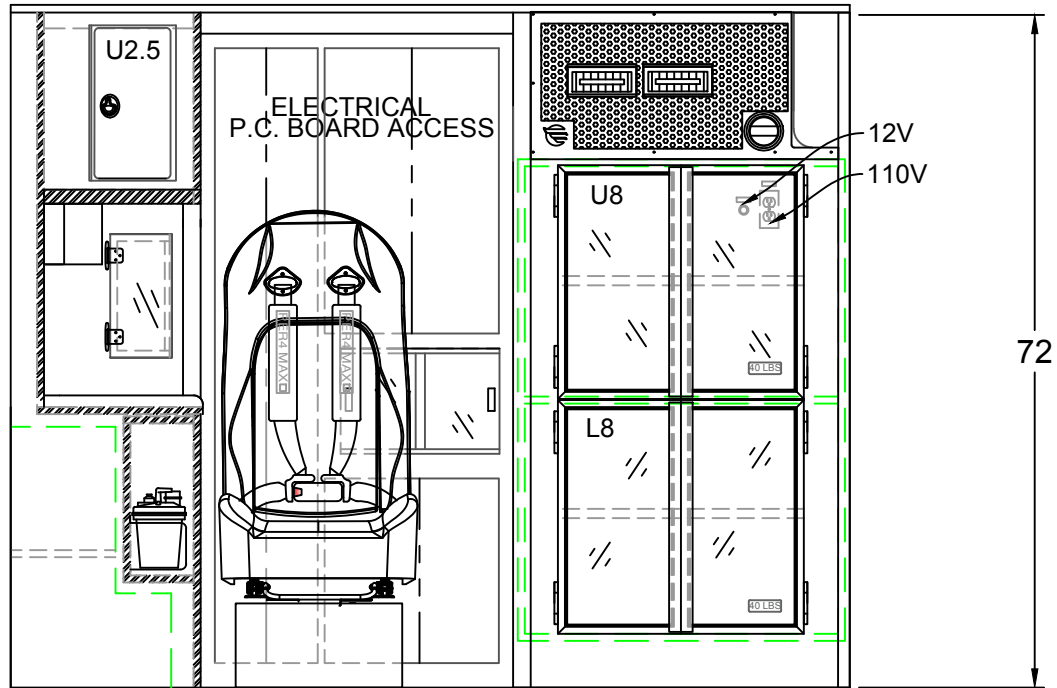

BE ADVISED THAT THESE ARE PRELIMINARY LAYOUTS INTENDED TO ILLUSTRATE DESIGN INTENT AND DIMENSIONS ARE FOR REFERENCE ONLY PRIOR TO FINAL ENGINEERING

<p>CABINET WEIGHT RATINGS: NON-RESTOCKING = 40 LBS. RESTOCKING = 30 LBS.</p>	<p>INTERIOR CABINET DIMENSIONS IN INCHES</p>							 <p>TYPE 9 CHEVY 2021 BULKHEAD INTERIOR</p>	
	CABINET	HEIGHT	WIDTH	DEPTH	CABINET	HEIGHT	WIDTH		DEPTH
	U8	24.50	33.50	32.50					
	L8	24.50	33.50	32.50					
								DATE 2/15/21	SCALE
								DRAWN BY AP	DWG NO 4 / 9

44" AISLE

CA166000

MODEL 9170C

170 x 95 x 72

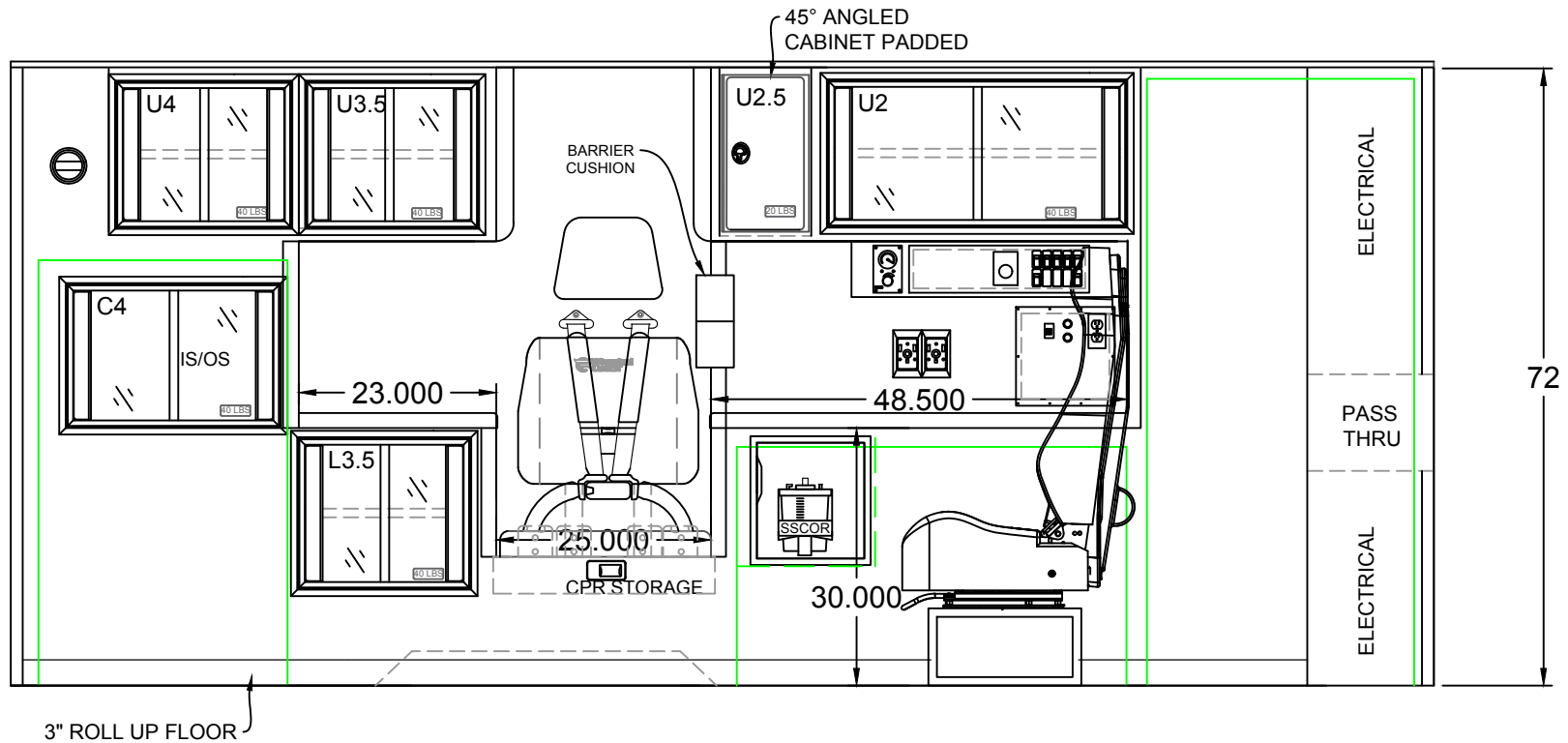

INTERIOR CABINET DIMENSIONS IN INCHES

CABINET	HEIGHT	WIDTH	DEPTH		CABINET	HEIGHT	WIDTH	DEPTH	
C4	17.00	24.50	IS/OS		CPR	5.25	23.50	20.50	
U4	17.25	20.50	20.50		L3.5	17.75	20.25	20.50	
U3.5	17.25	20.25	20.50						
U2.5	18.00	12.00	18.25						
U2	18.75	35.00	18.25						

44" AISLE

CABINET WEIGHT RATINGS:  
NON-RESTOCKING = 40 LBS.  
RESTOCKING = 30 LBS.

BE ADVISED THAT THESE ARE PRELIMINARY LAYOUTS INTENDED TO ILLUSTRATE DESIGN INTENT AND DIMENSIONS ARE FOR REFERENCE ONLY PRIOR TO FINAL ENGINEERING



TYPE 9 CHEVY 2021

LEFT INTERIOR

DATE:	2/15/21	SCALE:	
DWN BY:	AP	DWG NO:	5 / 9

CA166000

MODEL 9170C

170 x 95 x 72

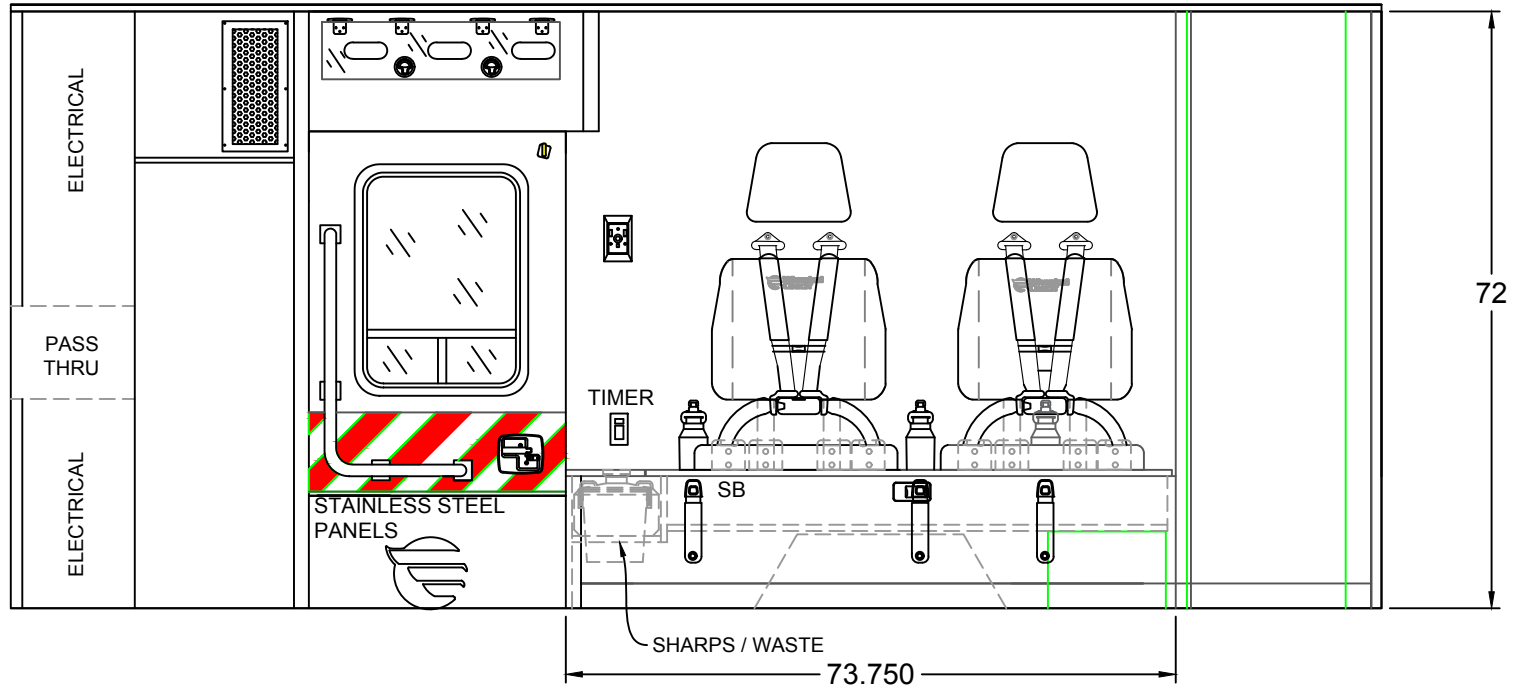

INTERIOR CABINET DIMENSIONS IN INCHES

COMPT.	HEIGHT	WIDTH	DEPTH		COMPT.	HEIGHT	WIDTH	DEPTH	
SB	6.00	61.50	20.00						

44" AISLE

CABINET WEIGHT RATINGS:  
NON-RESTOCKING = 40 LBS.  
RESTOCKING = 30 LBS.

BE ADVISED THAT THESE ARE PRELIMINARY LAYOUTS INTENDED TO ILLUSTRATE DESIGN INTENT AND DIMENSIONS ARE FOR REFERENCE ONLY PRIOR TO FINAL ENGINEERING



TYPE 9 CHEVY 2021  
RIGHT INTERIOR

DATE: 2/15/21	SCALE:
DRAWN BY: AP	DWG NO: 6 / 9

CA166000

MODEL 9170C

170 x 95 x 72

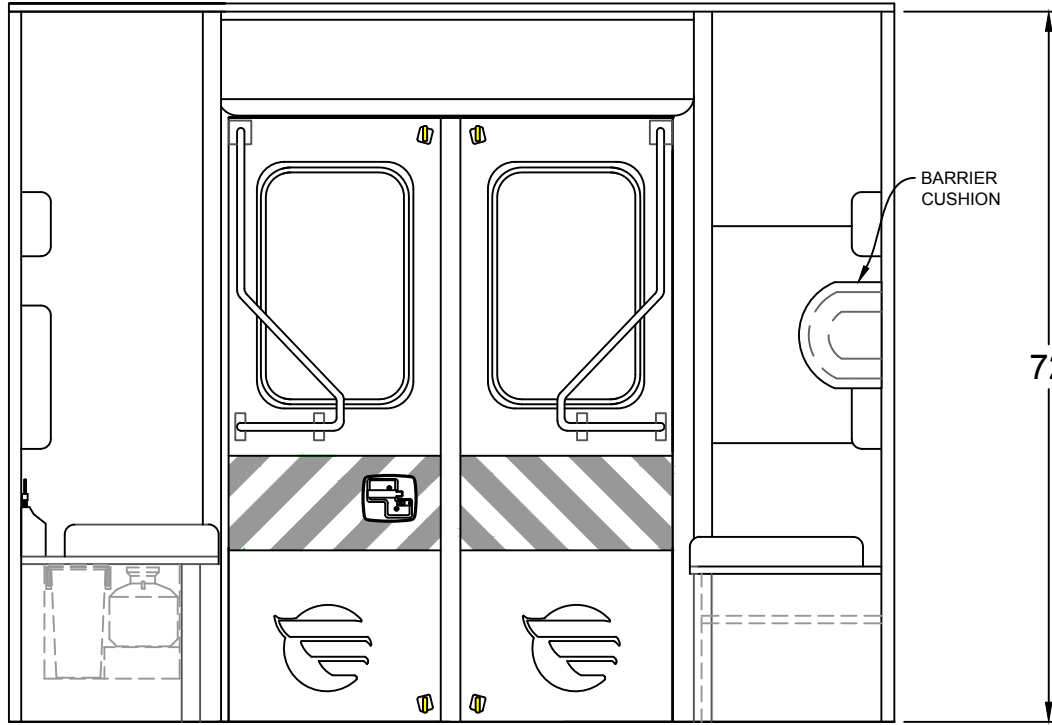

INTERIOR CABINET DIMENSIONS IN INCHES

COMPT.	HEIGHT	WIDTH	DEPTH		COMPT.	HEIGHT	WIDTH	DEPTH	

44" AISLE

CABINET WEIGHT RATINGS:  
NON-RESTOCKING = 40 LBS.  
RESTOCKING = 30 LBS.

BE ADVISED THAT THESE ARE PRELIMINARY LAYOUTS INTENDED TO ILLUSTRATE DESIGN INTENT AND DIMENSIONS ARE FOR REFERENCE ONLY PRIOR TO FINAL ENGINEERING



TYPE 9 CHEVY 2021

REAR BULKHEAD INTERIOR

DATE: 2/15/21

SCALE

DWGN BY: AP

DWG NO: 7 / 9

CA166000

MODEL 9170C

170 x 95 x 72

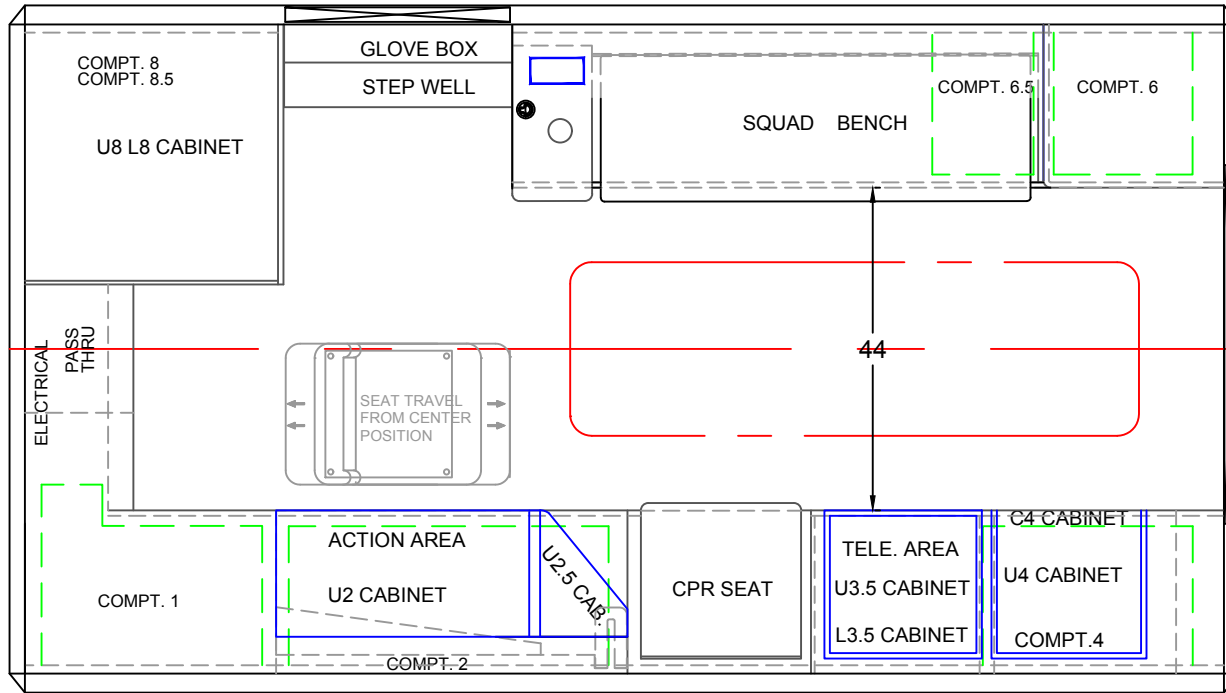

BE ADVISED THAT THESE ARE PRELIMINARY LAYOUTS INTENDED TO ILLUSTRATE DESIGN INTENT AND DIMENSIONS ARE FOR REFERENCE ONLY PRIOR TO FINAL ENGINEERING

INTERIOR CABINET DIMENSIONS IN INCHES

CABINET	HEIGHT	WIDTH	DEPTH	CABINET	HEIGHT	WIDTH	DEPTH



TYPE 9 CHEVY 2021  
FLOOR PLAN

DATE: 2/15/21 SCALE  
DWN BY: AP DWG NO: 8 / 9

44" AISLE



CA166000

MODEL 9170C

170 x 95 x 72

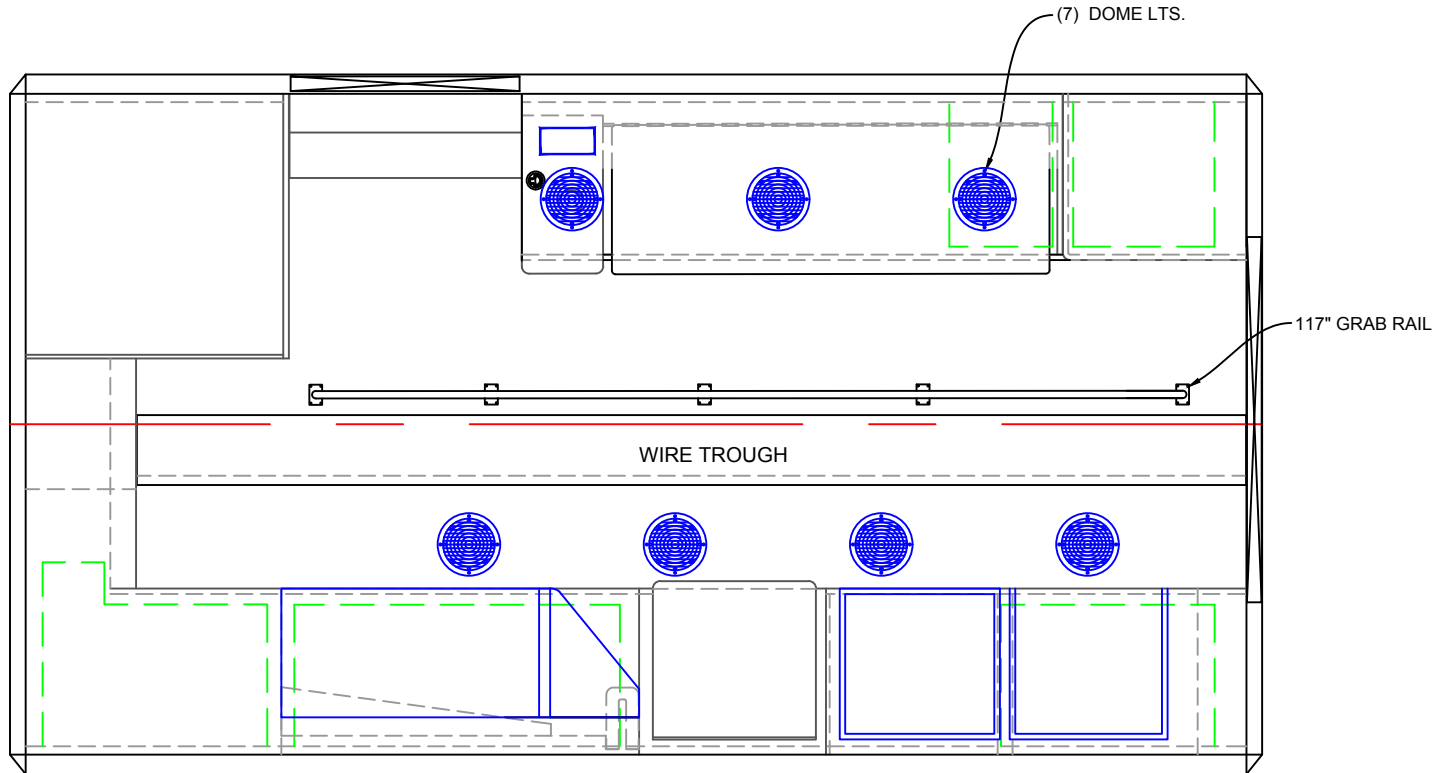

BE ADVISED THAT THESE ARE PRELIMINARY LAYOUTS INTENDED TO ILLUSTRATE DESIGN INTENT AND DIMENSIONS ARE FOR REFERENCE ONLY PRIOR TO FINAL ENGINEERING

INTERIOR CABINET DIMENSIONS IN INCHES									
CABINET	HEIGHT	WIDTH	DEPTH	CABINET	HEIGHT	WIDTH	DEPTH		
									TYPE 9 CHEVY 2021
									DATE: 2/15/21
									SCALE
									DWN BY AP
									DWG NO 9 / 9

44" AISLE